

Wireless LAN Connection Guide

Precautions When Using Wireless LAN	2
Preparing to Use a Wireless LAN Environment	2
Checking the Network Environment to Be Used on the Wireless LAN	2
Selecting a Method to Set Up the Wireless LAN	3
Connecting Using WPS	3
Connecting by Selecting a Wireless LAN Access Point from the Control Panel	5
Connecting by Manual Setup from Control Panel	8
Confirming if Connections Are Normal	11
Connecting in Wireless LAN (AP Mode)	12
Glossary	14

• Precautions When Using Wireless LAN

Carefully read the following precautions before using the machine in a wireless LAN environment.

- In a wireless LAN environment, the machine enters sleep mode, but does not enter deep sleep mode.
- Do not place any devices (especially microwave ovens or digital cordless telephones) that emit weak electromagnetic waves near the machine.
- Install the machine near a wireless LAN access point or wireless device with no obstacles between them (the distance should be within 30 m).
- Wireless connections may be difficult if there is any metal, aluminum framed windows, or reinforced concrete walls between the machine and the wireless LAN access point.
- Wireless LAN connections may have slower transmission speeds, depending on the environment, than wired LAN or USB connections. We recommend using a wired LAN or a USB connection to print large amounts of data, such as photographs.
- The illustrations of the machine and the control panel in this manual use the MC363dnw as an example. For how to use the actual control panel, see the user manual for the machine you purchased.

! Note

- The wireless LAN function may be disabled in the default factory settings. If this is the case, you need to first set the wireless LAN to [Enable] on the control panel.

• Preparing to Use a Wireless LAN Environment

Checking the Network Environment to Be Used on the Wireless LAN

You can communicate via a wireless LAN access point to connect to a wireless LAN environment (WPS compatible).

Before you start, confirm that the wireless LAN access point you are using supports the following environment.

Item	Value
Standard	IEEE 802.11 a/b/g/n

- You cannot use wireless (infrastructure) and the wireless (AP mode) at the same time.

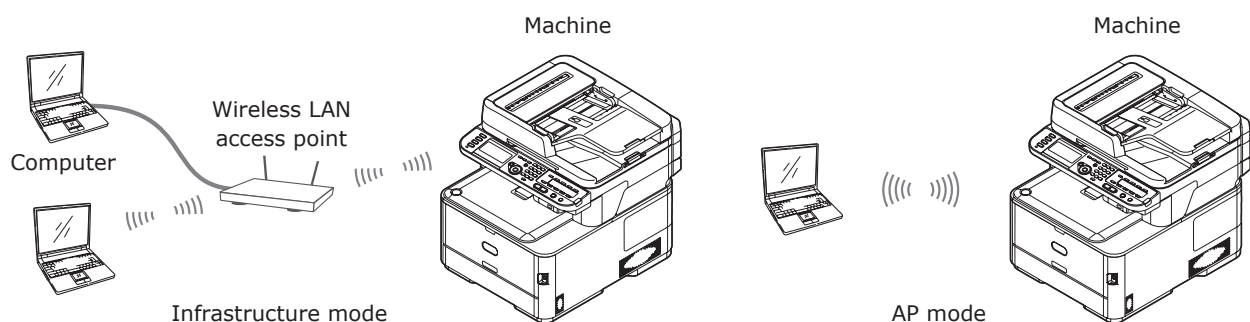

Selecting a Method to Set Up the Wireless LAN

Confirm that the wireless LAN access point you are using supports WPS and then select the setup method.

If you do not know whether WPS is supported, use the "WPS not supported" setup method.

- **WPS supported**  → **Connecting Using WPS..... P.3**
- **WPS not supported** → **Connect by selecting a wireless LAN access point from the control panel P.5**

• Connecting Using WPS

If the wireless LAN access point supports WPS, the connection to the wireless LAN can be made easily by using the easy setup button (WPS button).

Follow the procedure below for the setup.

- 1 Confirm the position of the easy setup button and when to press the button by referring to the user manual of the wireless LAN access point.
- 2 Confirm that the wireless LAN access point has been activated and is functioning normally.
- 3 Turn on the power supply to the machine.

 Memo

- For how to turn on the power, see the user manual for the machine you purchased.

- 4 When the [Wireless Setting] screen is displayed, select [Yes], and press the  button.

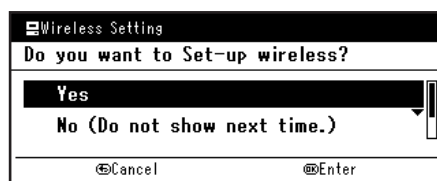



Use the following procedure if the above screen does not appear or the wireless setup needs to be reset.

- (1) Press the <SETTING> button on the control panel.

 Memo

- This operation is unnecessary depending on your model.

- (2) Press  to select [Wireless Setting], and then press the  button.

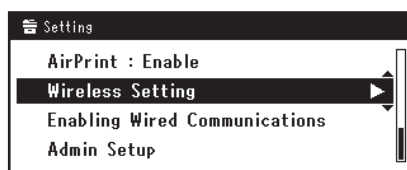

- 5 Enter the administrator password, select [Enter], and press the **OK** button.

Memo

- The default factory-set password is "999999".

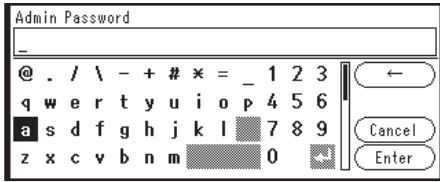

The following message will be displayed for about 5 seconds.

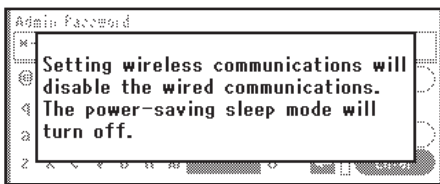

- 6 Select [Enable], and press **OK**.

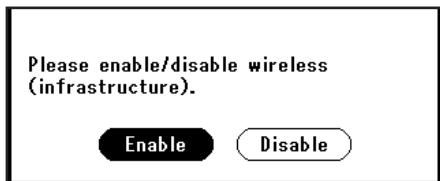

- 7 Select [Automatic setup (WPS)], and press **▶**.

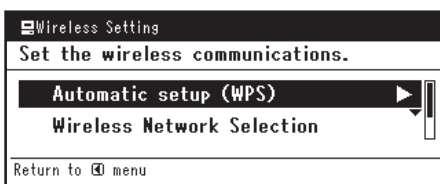

- 8 Select [WPS-PBC], and press **▶**.

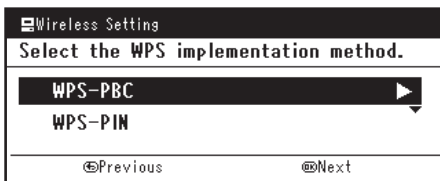

- 9 Select [Yes], and press **OK**.

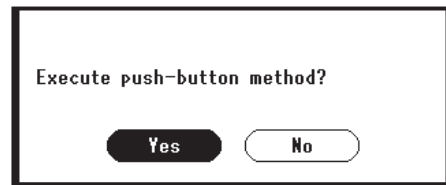

- 10 The machine starts searching for wireless LAN access points. The following screen is displayed for 2 minutes. During those 2 minutes, press the easy setup button for the wireless LAN access point for a few seconds.

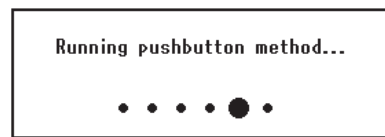

- 11 When the following screen is displayed, the wireless LAN setup is complete.

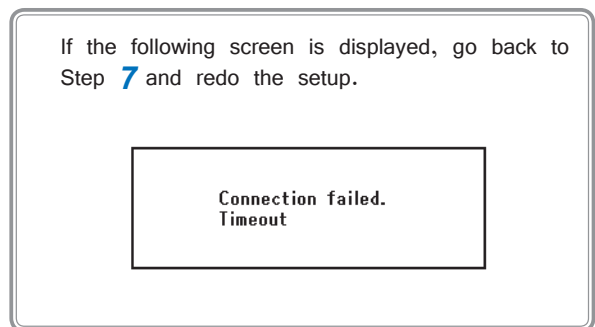
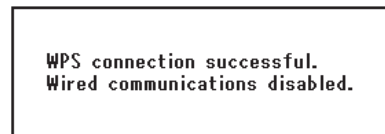

- 12 Advance to "Confirming if Connections Are Normal" (P.11).

• Connecting by Selecting a Wireless LAN Access Point from the Control Panel

If the wireless LAN access point does not support WPS, you can connect by selecting the wireless LAN access point you want to use from those the machine has detected. To do this, an encryption key is required.

Follow the procedure below for the setup.

- 1 Confirm and write down the SSID and encryption key by referring to the user manual of the wireless LAN access point.

 Memo

- The SSID is also called the network name, ESSID, or ESS-ID.
- The encryption key is also called the network key, security key, password, or pre-shared key.

- 2 Confirm that the wireless LAN access point has been activated and is functioning normally.

- 3 Turn on the power supply to the machine.

 Memo

- For how to turn on the power, see the user manual for the machine you purchased.

- 4 When the [Wireless Setting] screen is displayed, select [Yes], and press the **OK** button.

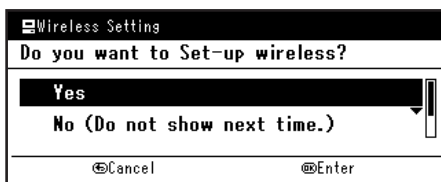

Use the following procedure if the above screen does not appear or the wireless setup needs to be reset.

- (1) Press the <SETTING> button on the control panel.

 Memo

- This operation is unnecessary depending on your model.

- (2) Press **▼** to select [Wireless Setting], and then press the **OK** button.

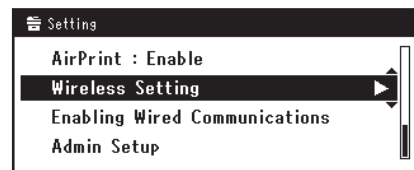

- 5 Enter the administrator password, select [Enter], and press the **OK** button.

 Memo

- The default factory-set password is "999999".

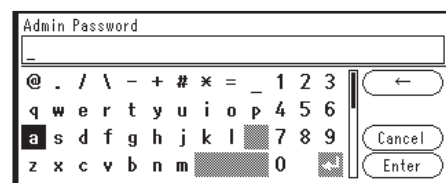

The following message will be displayed for about 5 seconds.

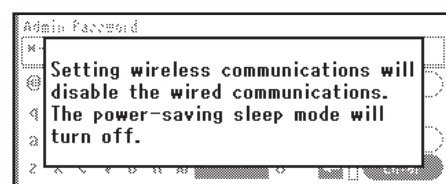

6 Select [Enable], and press (OK).



7 Press ▼ to select [Wireless Network Selection], and then press ►.

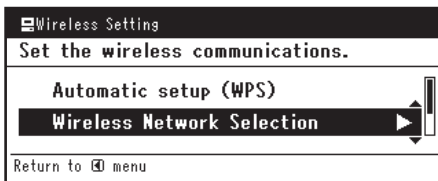

8 The machine starts searching for wireless LAN access points. Please wait.

9 A list of available wireless LAN access point SSIDs are displayed. Press ▼/▲, select a wireless LAN access point, and press the (OK) button.

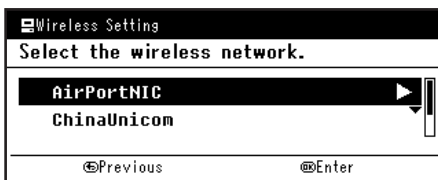

Note

- If only [Manual Setup] is displayed or the desired wireless LAN network SSID is not displayed, follow the procedure in "Connecting by Manual Setup from Control Panel" (P.8) to do the settings.

10 A screen opens in which to input the encryption key appropriate to the encryption procedure for the selected wireless LAN access point; input the encryption key.

Memo

- The encryption key differs depending on the wireless LAN access point and security.

■ If [Enter the Pre-shared Key.] is displayed

Item	Explanation
Encryption method	WPA/WPA2-PSK
Encryption key	Enter the pre-shared key.

■ If [To make this setting, make the changes from the web page.] is displayed

Item	Explanation
Encryption method	WPA/WPA2-EAP



* Configure from the machine's web page.

■ If [Input WEP Key] is displayed

Item	Explanation
Encryption method	WEP
Encryption key	Input the WEP key.

■ Other settings

Item	Explanation
Encryption method	Disable
Encryption key	Input is not necessary.

- 11** The SSID selected in Step **9** and the encryption method in Step **10** are displayed as security in  of the confirmation screen. If the SSID is the same as the one set up in Step **1**, select [Yes] and press the  button.

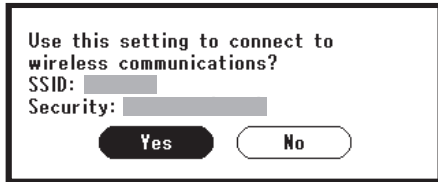

- 12** When the following screen is displayed, the wireless LAN setup is complete.

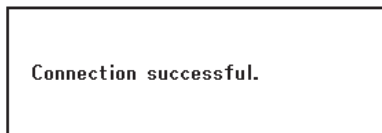

If the following screen is displayed, go back to Step **4-(2)** and redo the setup.

A rectangular box with a black border containing the text "Connection failed." centered inside.

Connection failed.

- 13** Advance to "Confirming if Connections Are Normal" (P.11).

• Connecting by Manual Setup from Control Panel

Configure the wireless LAN access point information (SSID, encryption method, and encryption key) manually, and connect to the wireless LAN.

Follow the procedure below for the setup.

- 1 Check and write down the SSID, the encryption method and the encryption key by referring to the user manual of the wireless LAN access point.

Note

- When the encryption method is WPA-EAP or WPA2-EAP, configure from the machine's web page.

Memo

- The SSID is also called the network name, ESSID, or ESS-ID.
- The encryption key is also called the network key, security key, password, or pre-shared key.

- 2 Confirm that the wireless LAN access point has been activated and is functioning normally.
- 3 Turn on the power supply to the machine.
- 4 When the [Wireless Setting] screen is displayed, select [Yes], and press the **OK** button.

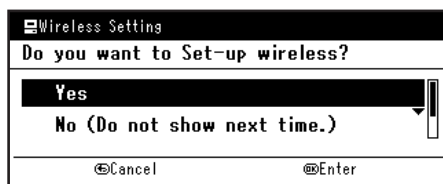

Use the following procedure if the above screen does not appear or the wireless setup needs to be reset.

- (1) Press the <SETTING> button on the control panel.

Memo

- This operation is unnecessary depending on your model.

- (2) Press **▼** to select [Wireless Setting], and then press the **OK** button.

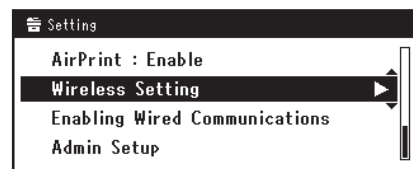

- 5 Enter the administrator password, select [Enter], and press the **OK** button.

Memo

- The default factory-set password is "999999".

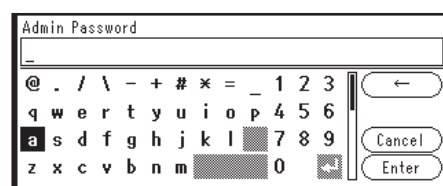

The following message will be displayed for about 5 seconds.

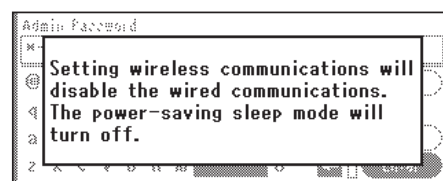

- 6 Select [Enable], and press **OK**.



- 7 Press **▼** to select [Wireless Network Selection], and then press **▶**.

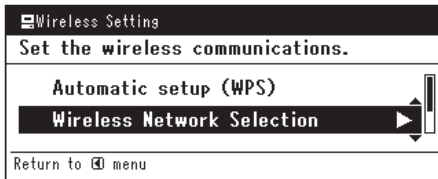

- 8 Search for wireless LAN access points starts. Please wait.

- 9 A list of available wireless LAN access points is displayed. Select [Manual Setup] at the end of the list, and press the **OK** button.

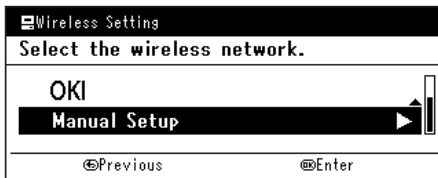

- 10 When [Enter the SSID.] is displayed, press **▶**.

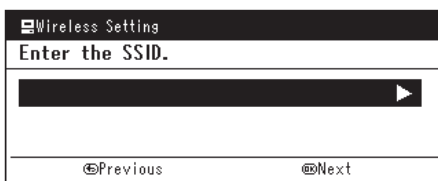

- 11 Enter the SSID, and select [Enter].



- It is case sensitive. Please enter it correctly.

- 12 When [Set the security.] is displayed, select the encryption method confirmed in Step 1, and press the **OK** button.



- If the wireless LAN access point supports Wep, WPA-PSK and WPA2-PSK, select WPA2-PSK.



- The encryption key differs depending on the wireless LAN access point and security.

- 13 When [Set the encryption type.] is displayed, select AES.

- 14 When [Enter the Pre-shared Key.] is displayed, press **▶** to display the input screen.

- 15 Enter the pre-shared key as the encryption key on the displayed screen.

- 16 The SSID entered in Step 11 and the security setting selected in Step 13 are displayed in  of the confirmation screen. If the content is the same as the one set up in Step 1, select [Yes] and press the **OK** button.

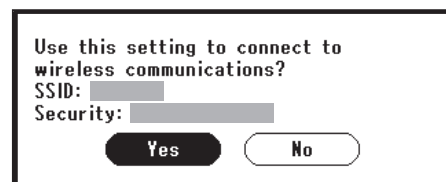

- It will take about 30 seconds for the machine to detect the wireless LAN access point.

- 17** When the following screen is displayed, the wireless LAN setup is complete.

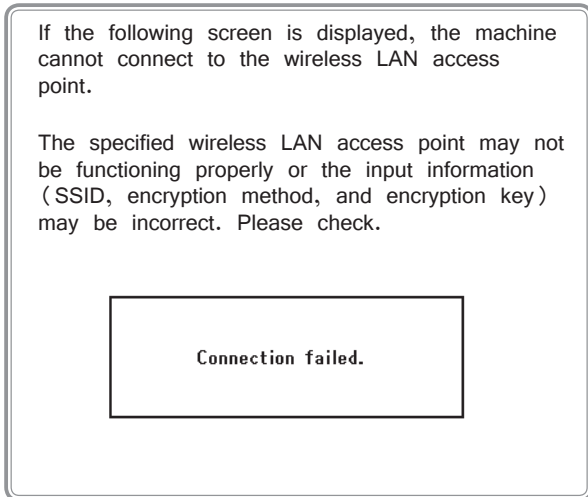
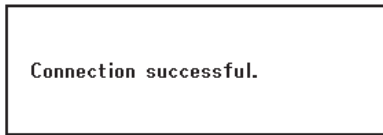

- 18** Advance to "Confirming if Connections Are Normal" (P.11).

• Confirming if Connections Are Normal

This section explains the procedure for confirming if connections to the wireless LAN are normal. Follow the procedure below to confirm the connection.

- 1 Press the <SCAN> button on the multi function printer.
- 2 The connection is normal if the antenna mark appears on the upper right of the control panel.

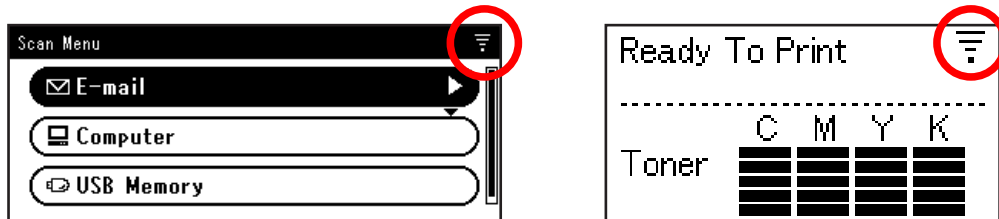

If the wireless LAN connection is unstable

If the wireless LAN connection is unstable, carefully read the precautions in "Precautions When Using Wireless LAN" (P.2) and then change the position of the machine or the wireless LAN access point.

If that does not resolve the problem, move the machine and the wireless LAN access point closer together.

• Connecting in Wireless LAN (AP Mode)

The wireless LAN (AP mode) connects directly to a wireless terminal (computer, tablet, smartphone, etc.) without using a wireless LAN access point.

! Note

- You cannot enable wireless LAN (infrastructure) and wireless LAN (AP mode) at the same time.
- If you enable wireless LAN (AP mode), the machine enters sleep mode, but does not enter deep sleep mode.
- Do not place any devices (especially microwave ovens or digital cordless telephones) that emit weak electromagnetic waves near the machine.
- Wireless connections may be difficult if there is any metal, aluminum framed windows, or reinforced concrete walls between the machine and the wireless terminal (computer, tablet, smartphone, etc.).
- Wireless LAN connections may have slower transmission speeds than wired LAN or USB connections, depending on the environment. We recommend using a wired LAN or a USB connection to print large amounts of data, such as photographs.

Preparing to use the wireless LAN (AP mode)

The machine becomes a simple wireless access point, and wireless terminals (computer, tablet, smartphone, etc.) can connect directly to it.

Before you start, confirm that the wireless device you are using supports the following environment.

Item	Value
Standard	IEEE 802.11 b/g/n
Security	WPA2-PSK(AES)

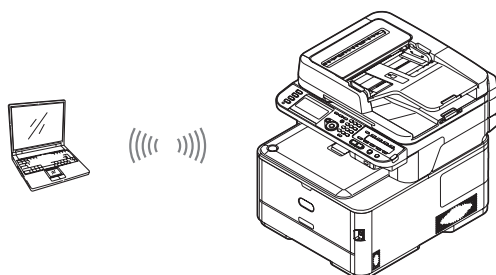

Confirm the method to set up the wireless LAN (AP mode)

Confirm that the wireless terminal (computer, tablet, smartphone, etc.) you are using supports WPS-PBC (push button) and then select the setup method.

If WPS-PBC is supported, refer to "Automatic Setup (Push Button)". If you do not know whether WPS is supported, refer to "Manual connections".

- **Automatic Setup (Push Button)**
If the wireless terminal (computer, tablet, smartphone, etc.) supports WPS-PBC (push button), then you can use the WPS button to connect via wireless LAN (AP mode).
- **Manual connections**
If the wireless terminal (computer, tablet, smartphone, etc.) does not support WPS-PBC (push button), then you can input the machine's SSID and password into the wireless terminal (computer, tablet, smartphone, etc.) to connect.

Automatic Setup (Push Button)

If the wireless terminal (computer, tablet, smartphone, etc.) supports WPS-PBC (push button), then you can use the WPS button to connect via wireless (AP mode).

Follow the procedure below to connect.

- 1 Confirm the position of the WPS button in the user's manual provided with the wireless terminal (computer, tablet, smartphone, etc.).
- 2 Turn on the power supply to the machine.
- 3 Press the <SETTING> button on the control panel.

4 Press [Admin Setup].

- [Wireless(AP Mode) Setting] can be selected here depending on your model.

5 Enter the administrator password and press **OK**.

The default factory-set administrator password is "999999".

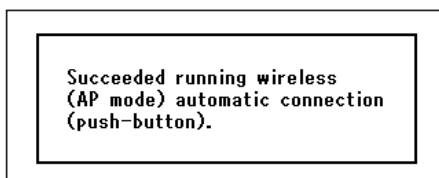
6 Press **▼** to select [Network Menu], and then press **OK**.**7** Select [Network], and then press **OK**.**8** Select [Wireless(AP Mode) Setting], and then press **OK**.**9** Select [Enable] (or [Yes]), and then press **OK**.**10** Select [Automatic Setup (Push Button)], and then press **OK**.**11** Press [Yes].**12** Start WPS-PBC (push button) on the wireless terminal (computer, tablet, smartphone, etc.). The wireless LAN setup is complete when the following screen is displayed.

Manual connections

If the wireless terminal (computer, tablet, smartphone, etc.) does not support WPS-PBC (push button), then you can input the machine's SSID and password into the wireless terminal (computer, tablet, smartphone, etc.) to connect.

Follow the procedure below to connect.

1 Turn on the power supply to the machine.**2** Press <SETTING> on the control panel.**3** Select [Admin Setup] and press **OK**.

- [Wireless(AP Mode) Setting] can be selected here depending on your model.

4 Enter the administrator password and press **OK**.

The default factory-set administrator password is "999999".

5 Select [Network Menu], and then press **OK**.**6** Select [Network], and then press **OK**.**7** Select [Wireless(AP Mode) Setting], and then press **OK**.

The following message will be displayed for about 5 seconds.

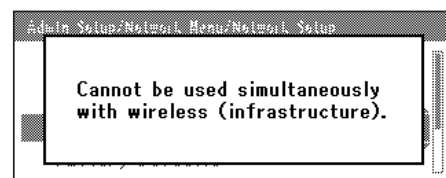
**8** Select [Enable], and press **OK**.**9** Select [Manual Setup], and press **OK**.**10** Confirm the [SSID] and [Password] that are displayed on the machine.**11** Input the machine's [SSID] and [Password] that were confirmed in step **10** for the wireless terminal (computer, tablet, smartphone, etc.).

• Glossary

- SSID

The ID to identify the connection to a device on a network. Wireless connections are possible by setting the SSID of the wireless LAN access point for the device to be connected to the machine.

The SSID is also called the network name, ESSID, or ESS-ID.

- Security (encryption method)

This security (encryption method) can be set to prevent illegal access to a network and interception of transmitted data when using wireless LAN.

The security (encryption method) settings must be the same settings on the machine and on the wireless LAN access point.

- WPS

This is a wireless LAN setting format standardized by the Wi-Fi Alliance, an industry organization for wireless LAN.

There are two setup formats, a push button format and a PIN code format.

- Push button format: Wireless LAN can be easily set up by just pressing the WPS button on the wireless LAN access point.

- PIN code format: Wireless LAN can be easily set up by registering an eight digit number assigned to the machine.

- Infrastructure mode

This mode communicates via a wireless LAN access point.

- AP mode

This mode allows the machine and the wireless terminal to communicate directly, without using a wireless LAN access point.

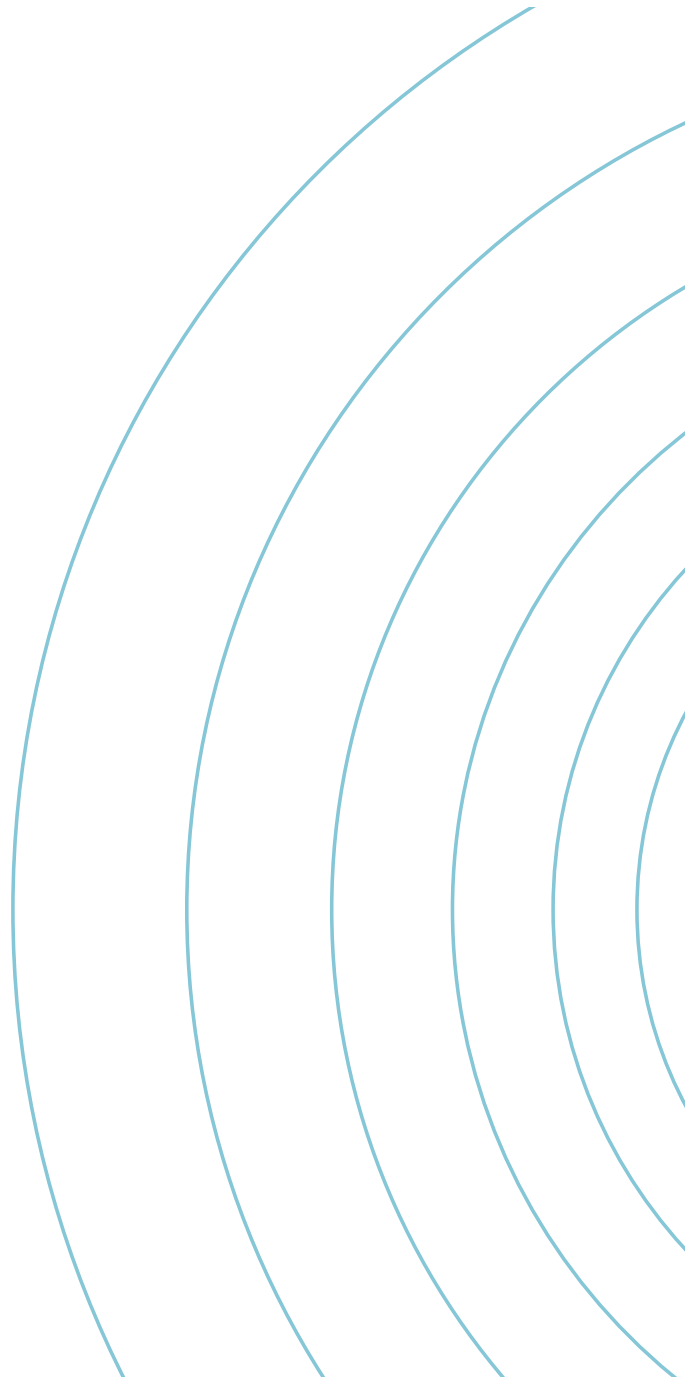

Oki Data Corporation
4-11-22 Shibaura, Minato-ku, Tokyo
108-8551, Japan