

C542/ES5442**User's Manual**

Table of contents

1 Before starting	4	3 Basic Operations	68
Cautions Related to Safety	5	Names of Components	69
General Cautions	6	Front View	69
About This Manual	8	Rear View	70
About Descriptions	8	Inside of the machine	70
Trademarks and Other Information	10	Basic Operations on the Operator Panel	71
License	12	Names and Functions	71
2 Setting Up	13	Name and Functions on the Touch Panel	72
Installation Requirements	14	Adjusting the Angle of the Operator Panel	73
Installation Environment	14	Entering Characters	74
Installation Space	15	Turning the Machine On or Off	76
Checking the Accessories	17	Turning the Machine On	76
Unpacking and Installing the Machine	18	Turning the Machine Off	77
Installing the Optional Equipment	21	Loading Paper	78
Installing the Wireless LAN module	21	About Paper Types That Can be Loaded	78
Installing the Additional Tray Unit	22	Loading Paper in Tray 1/2/3	81
Setting the Printer Driver	24	Loading Paper in the MP Tray	82
Connecting the Power Cord	26	Paper Storage	84
Connecting a LAN Cable/USB Cable	28	4 Print	85
Connecting a LAN Cable	28	Printing from a Computer (Windows)	86
Connecting a USB Cable	29	For Windows PCL Printer Driver	86
Loading Paper in the Tray	31	For Windows PS Printer Driver	87
Setting Up This Machine	33	Printing from a Computer (Mac OS X)	89
Language Setup	33	For Mac OS X	89
Setting Date and Time	35	Cancelling a Print Job	91
Setting the Administrator Password	37	About Screens and Functions of Each Printer Driver	92
Network Settings	38	Windows PCL Printer Driver	92
Test Print	40	Windows PS Printer Driver	94
Connecting to a Wireless LAN (Only When the Wireless LAN Module is Mounted)	42	Mac OS X PS Printer Driver	96
Before Connecting to a Wireless LAN	42	Names and Functions of Screen Items for Print	101
Enabling Wireless LAN Connection	43	5 Maintenance	102
Connecting to an Access Point (Infrastructure)	45	Replacing Consumables	103
Connecting to the Machine Directly	58	Cautions When Replacing Consumables	103
Installing a Driver and Software to a Computer	62	Replacing the Toner Cartridges	104
For Windows	62	Replacing the Image Drum	107
For Mac OS X	65	Replacing the Image Drum and Toner Cartridge at the Same Time	110
		Cleaning Each Part of the Machine	113
		Cleaning the LED Head	113

6	Troubleshooting	115
	If Paper Jams Occur	116
	If the Error Code is "370", "371", "372"	116
	If the Error Code is "380", "381", "382", "385", "389"	120
	If the Error Code is "390"	123
	If the Error Code is "391", "392", "393"	125
	If the Error Code is "409"	126
	Print Problems	130
	Unable to Print	130
	If an Error Message is Displayed on the Operator Panel	132
	Error Message List	132
7	Operating Management/Specifications	141
	Changing the Administrator Password	142
	Saving Power Consumption with the Power Save Function	143
	Setting the Length of Idle Time Before Entering Power Save Mode	143
	Setting the Length of Idle Time Before Entering Sleep Mode	144
	Restrictions in Power Saving Function	144
	Automatically Turning the Machine Off (Auto Power Off)	145
	Setting the Length of Idle Time Before Auto Power Off Works	146
	Specifications	147
	General Specifications	147
	Printing Specifications	148
	Network Specifications	149
	Wireless LAN Specifications (Option)	149
	Contact Us	151

1

Before starting

Cautions Related to Safety



General Cautions

About This Manual









Trademarks and Other Information









License



Cautions Related to Safety



 WARNING	Indicates additional information which, if ignored or not followed, may result in personal injury or death.
 CAUTION	Indicates additional information which, if ignored, may result in personal injury.

General Cautions

 WARNING	
	Do not touch the safety switch inside this machine. High voltage may occur, resulting in electric shock. Also, a gear may rotate, resulting in injury.
	Do not use a highly combustible spray near this machine. Some parts inside the machine become very hot, possibly resulting in fire.
	If the cover becomes extremely hot, the machine emits smoke or odor, or you hear a strange sound, unplug the power plug from the outlet, and contact your dealer. Fire may result.
	If liquid such as water gets inside the machine, unplug the power plug from the outlet, and contact your dealer. Fire may result.
	If you drop a clip or other foreign objects into the machine, unplug the power plug from the outlet, and take the foreign objects out. Electric shock, fire, or injury may result.
	Do not perform any operation or disassembly other than instructed in the user manual. Electric shock, fire, or injury may result.
	If the machine is dropped or the cover is damaged, unplug the power plug from the outlet, and contact your dealer. Electric shock, fire, or injury may result.
	Unplug the power plug regularly, and clean the bases of and in between the plug blades. If the power plug is left plugged into the outlet for an extended period of time, dust adheres on the bases of the plug blades, and a short may occur, possibly resulting in fire.

 WARNING	
	Do not vacuum spilled toner with an electric vacuum cleaner. Vacuuming spilled toner with an electric vacuum cleaner may result in ignition due to sparks from electric contacts or other reasons. If toner spills on the floor or other places, wipe the toner gently with a damp rag or other cloth while using care not to scatter the toner.
	Do not insert any object into a vent hole. Electric shock, fire, or injury may result.
	Do not place a cup filled with water or other objects on the machine. Electric shock or fire may result.
	Do not let pet urine or other liquid get inside this machine, or allow this machine to get wet. Electric shock or fire may result.
	When the machine cover is opened, do not touch the fuser unit. Burns may result.
	Do not throw the toner cartridge or image drum into a fire. The toner may ignite, resulting in burns.
	Do not connect the power cord, cables, or the ground wire in any way other than instructed in the user manual. Fire may result.
	Operation using an UPS (uninterruptible power supply) or inverter is not guaranteed. Do not use an uninterruptible power supply or inverter. Fire may result.

 CAUTION	
	Do not go near the paper output part when you turn the power on or when printing is in progress. Injury may result.

 CAUTION	
	Do not touch a broken liquid crystal display. Injury may result. If you get liquid (liquid crystal) spilled from the liquid crystal display into your eyes or mouth, immediately rinse with a large amount of water. Seek medical advice if necessary.
	Do not disassemble the image drum or toner cartridge, or force them open. You may inhale the scattered toner, or the toner may land on your hands or clothes, making them dirty.

NOTE!

This product is not intended for use in the immediate visual field on the display work place. To avoid disturbing reflections on the display work place, this product shall not be placed in the immediate field of vision.

About This Manual

Various information about this manual is provided here. Read these sections before using this manual.

• Disclaimer

Every effort has been made to ensure that the information in this document is complete, accurate, and up-to-date. The manufacturer assumes no responsibility for the result of errors beyond its control. The manufacturer also cannot guarantee that changes in software and equipment made by other manufacturers and referred to in this manual will not affect the applicability of the information in it. Mention of software products manufactured by other companies does not necessarily constitute endorsement by the manufacturer.

While all reasonable efforts have been made to make this document as accurate and helpful as possible, we make no warranty of any kind, expressed or implied, as to the accuracy or completeness of the information contained herein.

• Copyright of the manual

All rights reserved by Oki Data Corporation. No part of this document may be reproduced in any form or by any means without prior written permission from Oki Data Corporation.

© 2016 Oki Data Corporation

• Manual Composition

The following manual is included in this product.

- User's Manual (PDF) ----- Stored in the DVD-ROM which comes with the machine.
- Advanced Manual (PDF) ----- Download this manual from the Oki data web site and refer to it.
- Online Manual ----- Can be browsed on the Oki data web site.

• About Descriptions

About Descriptions

Marks, symbols, illustrations, and other descriptions are provided.

- About Marks
- About Symbols
- About Illustrations



Unless otherwise specified, this manual uses screenshots of the following screens.

- For Windows: Windows 7
- For Mac OS X: Mac OS X 10.9

[OKI Printer] may be written as the model name.

Depending on your OS, model or version, the description on this document may be different.

About Marks

This manual uses the following marks.

Symbol	Meaning
	Indicates the cautions and restrictions for operating this machine correctly. Be sure to read to ensure that you can operate the machine correctly.
	Indicates information that is useful for using this machine. It is recommended to read.
	Indicates a reference topic. Read when you need more information.
	Indicates a related topic. Read when you need related information.

About Symbols

This section describes symbols and their meaning in this manual.

Symbol	Meaning
Illustration (button name)	Indicates a button (button name) on the operator panel of the machine.

Symbol	Meaning
[]	Indicates a menu name, item name, option, or other items that are displayed on the display screen on the operator panel. Indicates a menu, window, or dialog box name that is displayed on the screen on a computer. They can be clearly distinguished in descriptions or illustrations in procedures.
" "	Indicates a message on the display screen or entered text. Indicates a file name on a computer. Indicates the topic title of a link destination.
< >	Indicates a key on the computer keyboard.
>	Indicates how to display the required menu of the machine or computer.

About Illustrations

The illustrations of C542 are used in this manual as examples.

Illustrations of the display screen on the operator panel used in this manual are with the factory default settings.



The descriptions in this manual may vary depending on your model.

Trademarks and Other Information

OKI is a registered trademark of Oki Electric Industry Co., Ltd.

Energy Star is a trademark of the United States Environmental Protection Agency.

Microsoft, Windows, Windows Server, Windows Vista and Internet Explorer are registered trademarks of Microsoft Corporation.

Apple, Macintosh, Mac and Mac OS are the registered trademarks of Apple Inc.

iPad, iPhone, iPod, iPod touch and Safari are trademarks registered to Apple Inc. in the United States and other countries.



AirPrint and the AirPrint logo are trademarks of Apple Inc.

Google, Google Docs, Android, and Gmail are trademarks of Google Inc.

Google Cloud Print is a trademark of Google Inc.

Adobe, Illustrator, Photoshop, PostScript and Reader are trademarks or trademarks of Adobe Systems Incorporated in the United States and other countries.

FeliCa is a registered trademark of Sony Corporation.

MIFARE is a trademark of NXP Semiconductors.

Other product names and brand names are registered trademarks or trademarks of their proprietors.

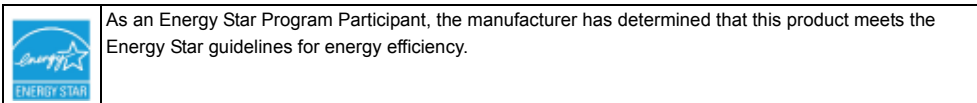

CE	This product complies with the requirements of the Council Directives 2014/30/EU (EMC), 2014/35/EU (LVD), 1999/5/EC (R&TTE), 2009/125/EC (ErP) and 2011/65/EU (RoHS), as amended where applicable, on the approximation of the laws of the member states relating to Electromagnetic Compatibility, Low Voltage, Radio & Telecommunications Terminal Equipment, Energy related Products and Restriction on the use of certain Hazardous Substances in electrical and electronic equipment.
-----------	--

The following cables were used to evaluate this product for EMC directive 2004/108/EC compliance, and configurations other than this may affect that compliance.

CABLE TYPE	LENGTH (METER)	CORE	SHIELD
Power	1.8	X	X
USB	5.0	X	✓
LAN	10.0	X	X
Telephone	3.0	X	X

• EMERGENCY FIRST AID

Take care with toner powder:



If swallowed, give small amounts of cold water and seek medical attention. DO NOT attempt to induce vomiting.

If inhaled, move the person to an open area for fresh air. Seek medical attention.

If it gets into the eyes, flush with large amounts of water for at least 15 minutes keeping eyelids open. Seek medical attention.

Spillages should be treated with cold water and soap to help reduce risk of staining skin or clothing.

• MANUFACTURER

Oki Data Corporation,
4-11-22 Shibaura, Minato-ku,
Tokyo 108-8551, Japan

- **IMPORTER TO THE EU/AUTHORISED REPRESENTATIVE**

OKI Europe Limited
Blays House
Wick Road
Egham
Surrey, TW20 0HJ
United Kingdom

For all sales, support and general enquiries contact your local distributor.

- **ENVIRONMENTAL INFORMATION**



License

This product contains software developed by the Heimdal Project.

Copyright (c) 1995 - 2008 Kungliga Tekniska Högskolan

(Royal Institute of Technology, Stockholm, Sweden).

All rights reserved.

Redistribution and use in source and binary forms, with or without modification, are permitted provided that the following conditions are met:

- 1 Redistributions of source code must retain the above copyright notice, this list of conditions and the following disclaimer.
- 2 Redistributions in binary form must reproduce the above copyright notice, this list of conditions and the following disclaimer in the documentation and/or other materials provided with the distribution.
- 3 Neither the name of the Institute nor the names of its contributors may be used to endorse or promote products derived from this software without specific prior written permission.

THIS SOFTWARE IS PROVIDED BY THE INSTITUTE AND CONTRIBUTORS "AS IS" AND ANY EXPRESS OR IMPLIED WARRANTIES, INCLUDING, BUT NOT LIMITED TO, THE IMPLIED WARRANTIES OF MERCHANTABILITY AND FITNESS FOR A PARTICULAR PURPOSE ARE DISCLAIMED. IN NO EVENT SHALL THE INSTITUTE OR CONTRIBUTORS BE LIABLE FOR ANY DIRECT, INDIRECT, INCIDENTAL, SPECIAL, EXEMPLARY, OR CONSEQUENTIAL DAMAGES (INCLUDING, BUT NOT LIMITED TO, PROCUREMENT OF SUBSTITUTE GOODS OR SERVICES; LOSS OF USE, DATA, OR PROFITS; OR BUSINESS INTERRUPTION) HOWEVER CAUSED AND ON ANY THEORY OF LIABILITY, WHETHER IN CONTRACT, STRICT LIABILITY, OR TORT (INCLUDING NEGLIGENCE OR OTHERWISE) ARISING IN ANY WAY OUT OF THE USE OF THIS SOFTWARE, EVEN IF ADVISED OF THE POSSIBILITY OF SUCH DAMAGE.

- **Open Source License Disclosure**

The following open source software is included to use Google Cloud Print. The descriptions about the open source license are as follows.

json-c

Copyright (c) 2009-2012 Eric Haszlakiewicz

Permission is hereby granted, free of charge, to any person obtaining a copy of this software and associated documentation files (the "Software"), to deal in the Software without restriction, including without limitation the rights to use, copy, modify, merge, publish, distribute, sublicense, and/or sell copies of the Software, and to permit persons to whom the Software is furnished to do so, subject to the following conditions:

The above copyright notice and this permission notice shall be included in all copies or substantial portions of the Software.

THE SOFTWARE IS PROVIDED "AS IS", WITHOUT WARRANTY OF ANY KIND, EXPRESS OR IMPLIED, INCLUDING BUT NOT LIMITED TO THE WARRANTIES OF MERCHANTABILITY, FITNESS FOR A PARTICULAR PURPOSE AND NON INFRINGEMENT. IN NO EVENT SHALL THE AUTHORS OR COPYRIGHT HOLDERS BE LIABLE FOR ANY CLAIM, DAMAGES OR OTHER LIABILITY, WHETHER IN AN ACTION OF CONTRACT, TORT OR OTHERWISE, ARISING FROM, OUT OF OR IN CONNECTION WITH THE SOFTWARE OR THE USE OR OTHER DEALINGS IN THE SOFTWARE.

Copyright (c) 2004, 2005 Metaparadigm Pte Ltd

Permission is hereby granted, free of charge, to any person obtaining a copy of this software and associated documentation files (the "Software"), to deal in the Software without restriction, including without limitation the rights to use, copy, modify, merge, publish, distribute, sublicense, and/or sell copies of the Software, and to permit persons to whom the Software is furnished to do so, subject to the following conditions:

The above copyright notice and this permission notice shall be included in all copies or substantial portions of the Software.

THE SOFTWARE IS PROVIDED "AS IS", WITHOUT WARRANTY OF ANY KIND, EXPRESS OR IMPLIED, INCLUDING BUT NOT LIMITED TO THE WARRANTIES OF MERCHANTABILITY, FITNESS FOR A PARTICULAR PURPOSE AND NON INFRINGEMENT. IN NO EVENT SHALL THE AUTHORS OR COPYRIGHT HOLDERS BE LIABLE FOR ANY CLAIM, DAMAGES OR OTHER LIABILITY, WHETHER IN AN ACTION OF CONTRACT, TORT OR OTHERWISE, ARISING FROM, OUT OF OR IN CONNECTION WITH THE SOFTWARE OR THE USE OR OTHER DEALINGS IN THE SOFTWARE.

2

Setting Up

Installation Requirements

Checking the Accessories

Unpacking and Installing the Machine

Installing the Optional Equipment

Connecting the Power Cord

Connecting a LAN Cable/USB Cable

Loading Paper in the Tray

Setting Up This Machine

Connecting to a Wireless LAN (Only When the Wireless LAN Module is Mounted)

Installing a Driver and Software to a Computer

Installation Requirements

- Installation Environment
 - Installation Space
-

Installation Environment

Install the machine in the following environment.

Ambient temperature: 10°C to 32°C

Ambient humidity: 20% to 80% RH (relative humidity)

Maximum wet bulb temperature: 25°C



- Use care to prevent condensation. It may cause a malfunction.
- If installing your machine where the ambient humidity is 30% RH or below, use a humidifier or antistatic mat.
- Depending on the installation environment, the operation noise may be louder. If the noise bothers you, we suggest you to install the machine in the place away from you or in another room.

WARNING

- Do not install the machine in a location subject to high temperatures or in a location near fire.
- Do not install the machine in a location where chemical reactions may occur (such as a laboratory).
- Do not install the machine near alcohol, thinners, or other flammable solvents.
- Do not install the machine in a location within the reach of small children.
- Do not install the machine in an unstable location (such as on an unsteady stand or slanted location).
- Do not install the machine in a location with high level of humidity or dust, or in a location where the machine is exposed to direct sunlight.
- Do not install the machine in an environment where it is exposed to salty air or corrosive gas.
- Do not install the machine in a location where it is exposed to a high level of vibration.
- Do not install the machine in a location where its vent hole is blocked.

CAUTION

- Do not install this machine directly on a thick rug or carpet.
- Do not install this machine in a closed room or other locations with bad circulation and ventilation.
- If you use this machine in a small room continuously for an extended period of time, make sure to ventilate the room.
- Install this machine away from a source that emits strong magnetic fields or noise.
- Install this machine away from a monitor or television.
- Moving the machine requires that two people stand in front and back of the machine respectively, hold the handles at the bottom of the machine, and move it.

Installation Space

Install the machine on a flat surface that is wide enough to accommodate the legs of the machine.

Allow for enough room around the machine as shown in the following figures.

• Top view

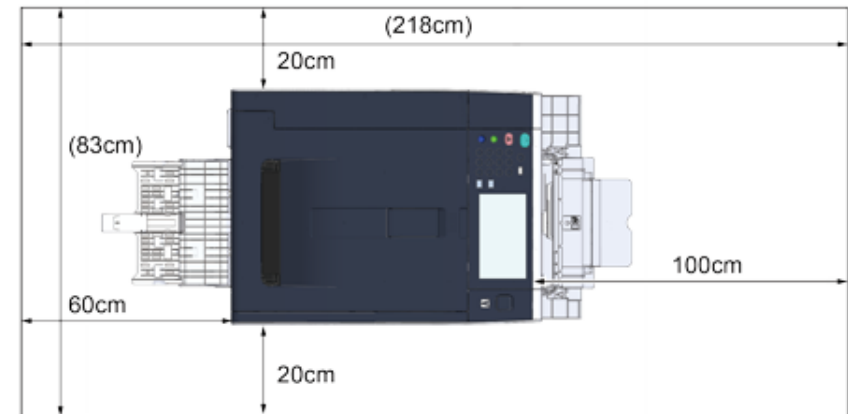

• Side view

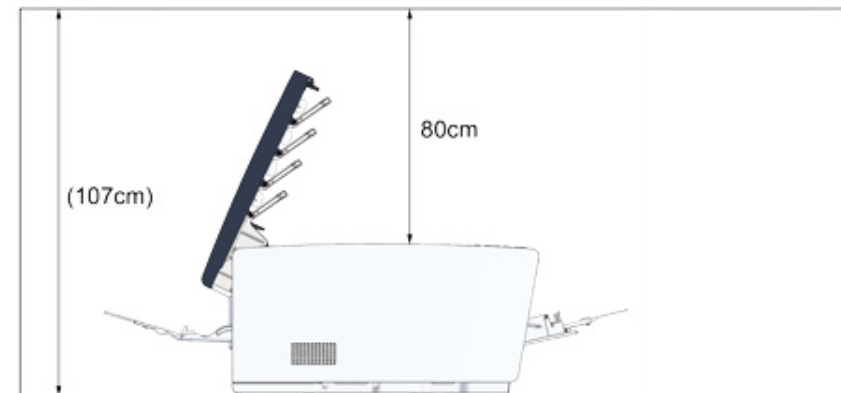

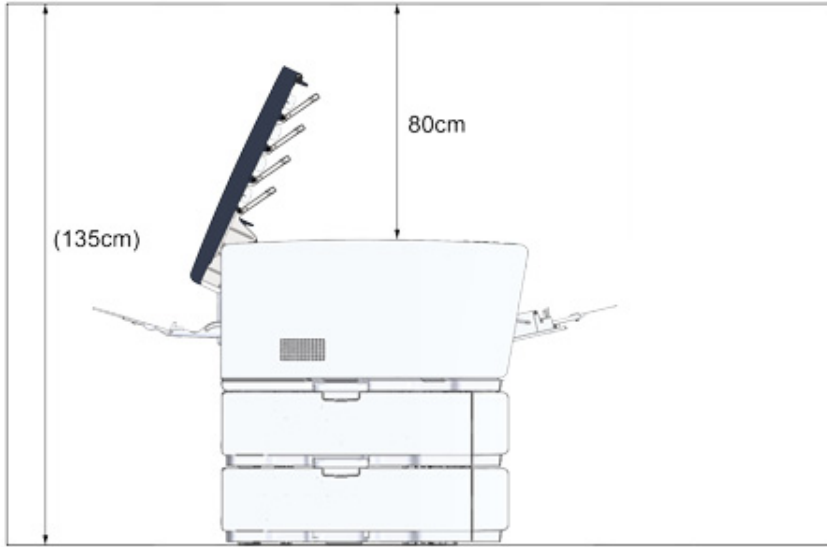

- Side view (when the additional tray unit is installed)



Checking the Accessories

Check that you have everything shown below.

 CAUTION	Injury may result.	
Lift this machine by 2 persons, because it weighs approximately 24 kg.		



Be sure to use the supplied consumables first. If other consumables are used first, the life time may not be shown correctly or supplied consumables may not be applied.

• Main body



• Four image drums (black, cyan, magenta and yellow)

• Four starter toner cartridges (black, cyan, magenta and yellow)

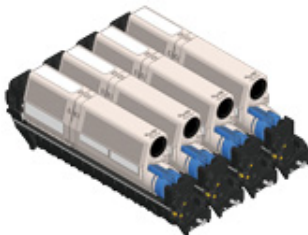

For the C model, the starter toner cartridges are installed in the image drums, which are installed in the machine before shipment.



The starter toner cartridge is not installed in the ES model. Install the toner cartridge that is included in this machine. Refer to "Replacing the Image Drum".

• Software DVD-ROM



• Power cord

• Envelope lever

The envelope lever is attached to the MP tray. Use the envelope lever if envelopes wrinkle after being printed.



For instructions, refer to the Advanced Manual.



- LAN cables or USB cables are not included in the package. Prepare the cable that suits your connection environment separately.
- Packaging and cushioning materials are used when transporting the machine. Do not dispose packaging materials as they may be used in the future.

Unpacking and Installing the Machine

This section describes how to unpack and install the machine.

 CAUTION	Injury may result.	
Lift this machine by 2 persons, because it weighs approximately 24 kg.		



- Use extra care when handling the image drum (the green cylinder), because it is fragile.
- Do not expose the image drum to direct sunlight or strong light (approximately 1,500 lux or more). Even under room lighting, do not leave the image drum for 5 minutes or more.
- Packaging and cushioning materials are required for transporting the machine. Do not dispose of it, and keep it for future use.

- 1 Remove the machine from the box, and then remove accessories, cushioning materials and the plastic bag from the machine.

- 2 Lift the machine, and then place it where it is to be installed.

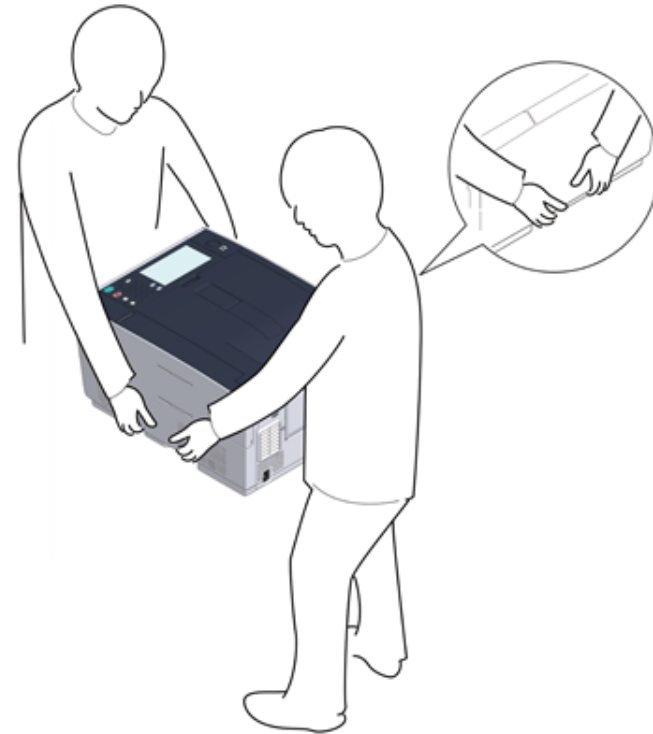

- 3 Remove the protection tapes, protective sheet, and desiccant packs.
- 4 Press the button (A) and open the output tray (a) completely.

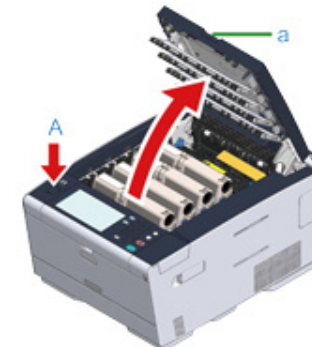

- 5** Pinch the tip of blue lever of the toner cartridge and turn forward until the tip aligns on the lug of the cartridge.
Turn the levers of all 4 toner cartridges.

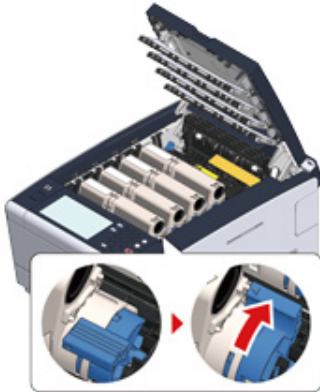

If you close the output tray without turning the blue lever, it may cause a malfunction. Be sure to turn the blue lever until its top aligns on the lug in the back of the toner cartridge.

- 6** Pull the locking levers on the fuser unit toward you to unlock.

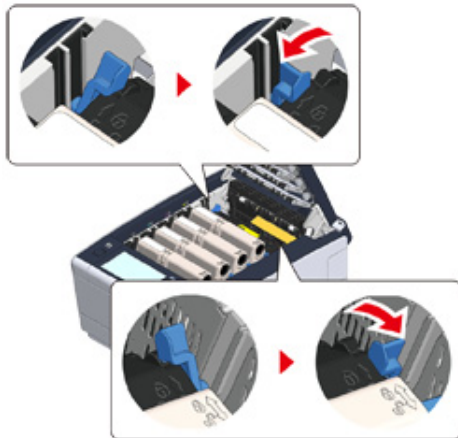

- 7** Hold the fuser unit handle and lift the fuser unit out of the machine.

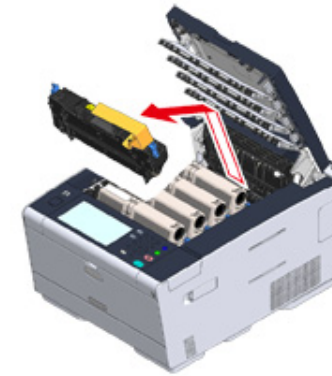

- 8** Push the blue lever on the fuser unit and remove the orange safety stopper and film.

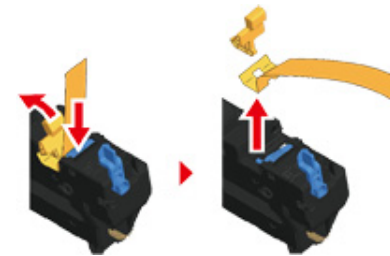

- 9 Hold the fuser unit handle and aligning the fuser unit to the grooves behind the toner cartridges, place the fuser unit into the machine.

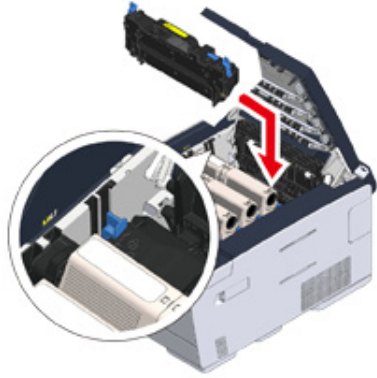

- 10 Push the levers on the fuser unit to lock.

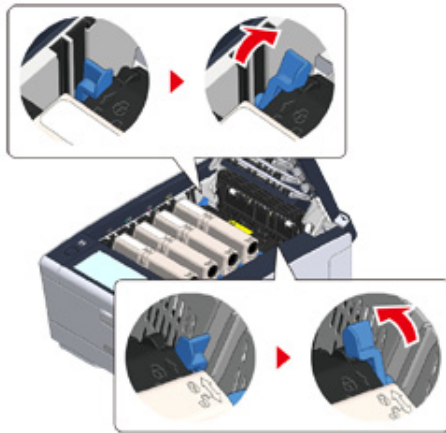

- 11 Close the output tray (a) slowly and push the center of the output tray for confirmation.

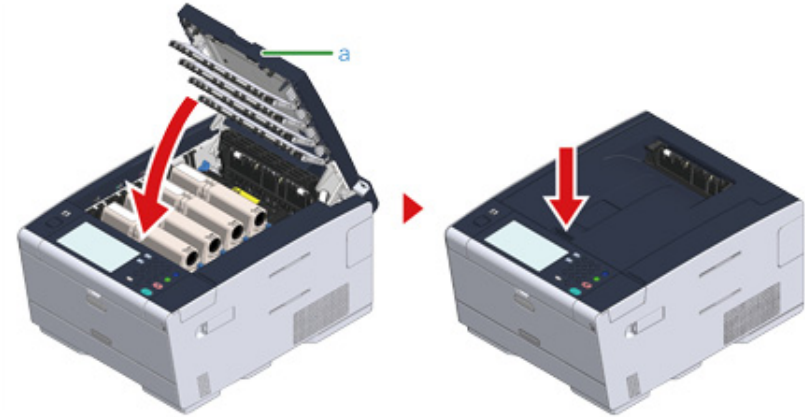

When the error message that the output tray is open does not disappear, make sure that the output tray is closed securely.

Installing the Optional Equipment

This section describes how to install optional equipment.

- Installing the Wireless LAN module
- Installing the Additional Tray Unit
- Setting the Printer Driver

Installing the Wireless LAN module

Install the wireless LAN module when you want to use a wireless connection.

After installing, be sure to change the wireless LAN setting from [DISABLE] to [ENABLE] on the operator panel.

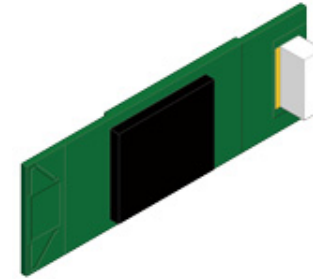

- 1 Check that the machine is turned off and power cord and all the cables are unplugged.



Installing the wireless LAN module with the machine turned on may cause the machine and wireless LAN module to malfunction.

- 2 Open the wireless LAN module cover.



- 3 Eject the connector from the cover and connect with the wireless LAN module.

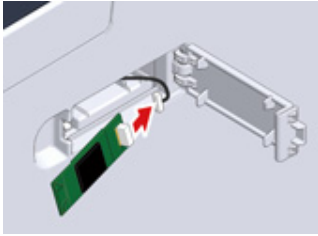

- 4 Install the wireless LAN module to the machine.

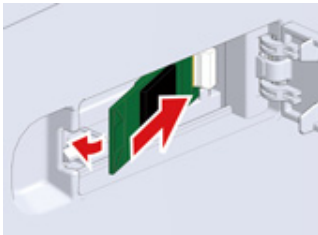

- 5 Close the wireless LAN module cover.

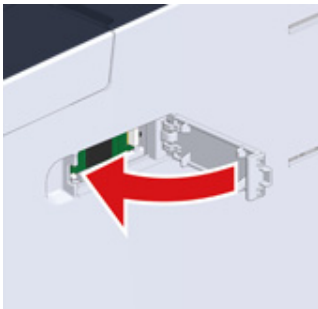

Go to "Connecting the Power Code".



Attaching the wireless module cannot connect the machine to the wireless LAN.

Enable the wireless setting in the steps in "Connecting to a Wireless LAN (Only When the Wireless LAN Module is Mounted)".

Installing the Additional Tray Unit

Attach the additional tray unit when increasing the number of sheets or paper to be set is needed.

Up to 2 trays can be installed.

Set the number of trays on the printer driver after installing them.

Model Number: N36501

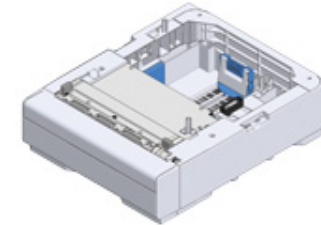

CAUTION

Injury may result.



Lift this machine by 2 persons, because it weighs approximately 24 kg.

- 1 Check that the machine is turned off and power cord and all the cables are unplugged.



Installing the additional tray unit with the machine turned on may cause the machine and additional tray unit to malfunction.

2 If you want to install two additional trays, fix them together with the lock pieces.

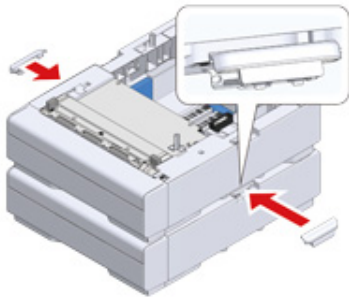

3 Slowly stack the machine on the additional tray unit aligning their back sides and right sides.

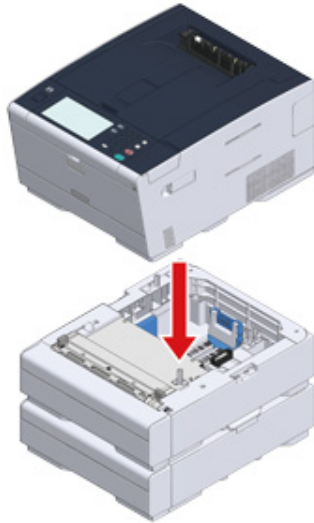

4 Screw the machine and additional tray unit with the lock pieces.



Setting the Printer Driver

When the additional tray unit is installed, be sure to set the number of trays after the printer driver is installed.

For the information of installing the printer driver, see "Installing a Driver and Software to a Computer".



- To follow this procedure, you must log in to a computer as the administrator.
- If your Mac OS applies to the following conditions, the information about the installed option is automatically obtained, not requiring you to set the printer driver.
 - When the machine is connected to a network over Bonjour
 - When the machine is connected via USB interface
 - When the optional equipment is installed before the printer driver is installed

• Setting Additional Tray(s) to the Windows PCL Printer Driver

- 1 Click [Start], and then select [Devices and Printers].
- 2 Right-click [OKI C542], and then select [OKI C542 PCL6] from [Printer properties].
- 3 Select the [Device Options] tab.

- 4 Enter the total number of trays and then click [OK].

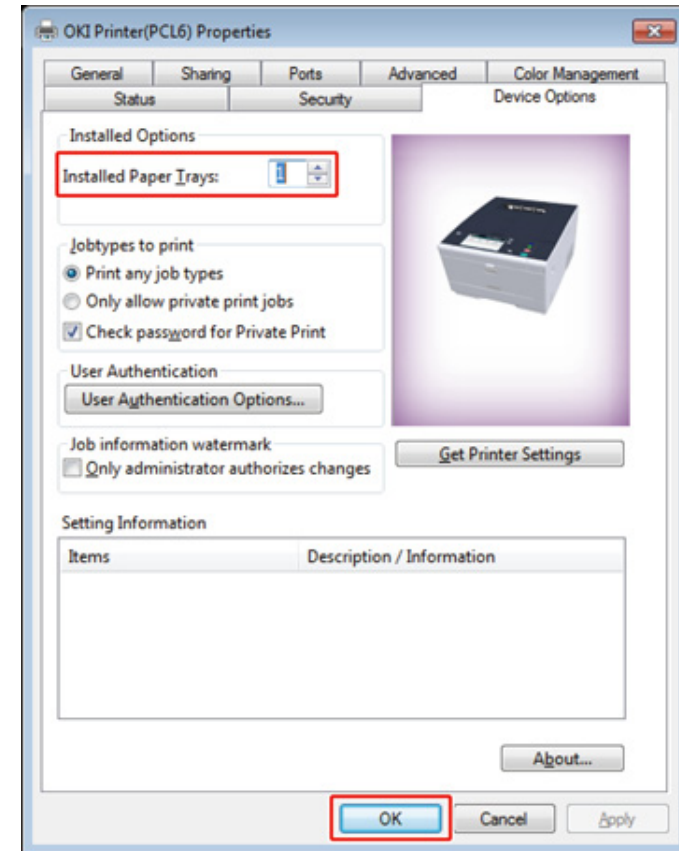

If a TCP/IP network connection is used, click [Get Printer Settings] to set the number of trays automatically.

• Setting Additional Tray(s) to the Windows PS Printer Driver

- 1 Click [Start], and then select [Devices and Printers].
- 2 Right-click [OKI C542], and then select [OKI C542 PS] from [Printer properties].
- 3 Select the [Device Settings] tab.

- 4 Select [Get installed options automatically] for [Installable Options], and then click [Setup].

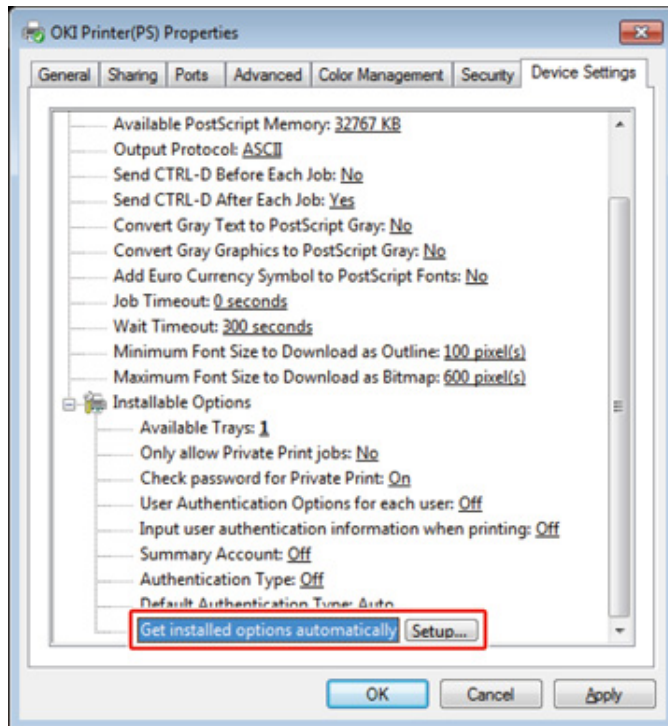

When using a USB connection, select the total number of trays for [Available Trays] in [Installable Options].

- 5 Click [OK].

• Setting Additional Tray(s) to the Mac OS X Printer Driver

- 1 Select [System Preferences] from the Apple menu.
- 2 Click [Printers & Scanners].
- 3 Select the machine, and then click [Options & Supplies].
- 4 Select the [Options] tab.

- 5 Select the total number of trays for [Available Tray], and then click [OK].

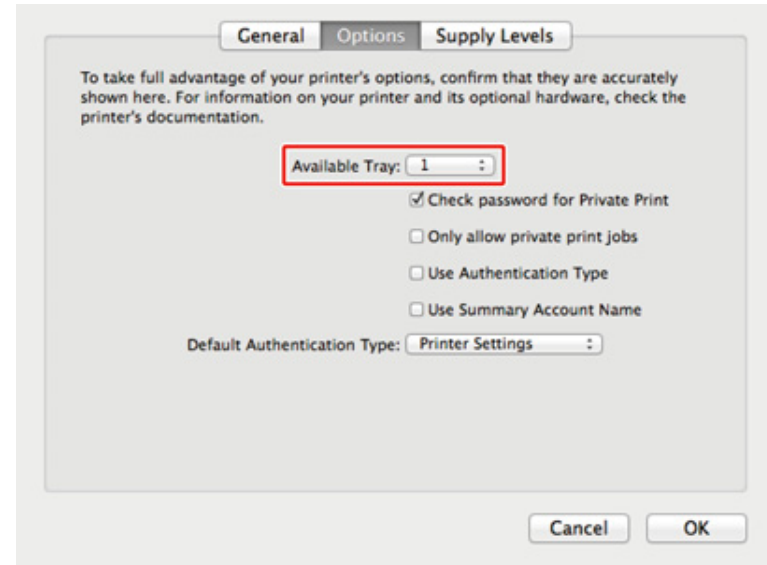

Connecting the Power Code

The power supply must meet the following conditions.

AC: 110 to 127V AC (Range 99 to 140V AC) / 220 to 240V AC (Range 198 to 264V AC)

Frequency: 50/60 Hz \pm 2%



- If the power supply is unstable, use a voltage regulator.
- The maximum power consumption of the machine is 1220 W (120V AC) / 1250 W (230V AC). Check that the power supply is sufficient.
- The operation that uses an uninterruptible power supply (UPS) or inverter is not guaranteed. Do not use an uninterruptible power supply (UPS) or inverter.



WARNING

Fire or electric shock may result.



- Be sure to turn this machine off before connecting and disconnecting the power cord and the ground wire.
- Be sure to connect the ground wire to the designated ground terminal. If this machine cannot be grounded, contact your dealer.
- Be sure not to connect the ground wire to the ground of a water pipe, gas pipe or telephone line, or to a lightning rod.
- Be sure to connect the ground wire before connecting the power cord to the outlet. Also, be sure to unplug the power cord from the outlet before disconnecting the ground wire.
- Be sure to plug or unplug the power cord by holding its power plug.
- Securely plug the power cord into the outlet.
- Do not plug or unplug the power cord with wet hands.
- Install the power cord in a location where users cannot step on it, and do not place any object on the power cord.
- Do not bundle or tie the power cord.
- Do not use a damaged power cord.
- Do not overload the outlet.
- Do not connect the power cords of this machine and other electric products to the same outlet. If the power cord of this machine is connected to the same outlet as other electric products, especially an air conditioning machine, copier, or shredder, this machine may malfunction due to electrical noise. If you have to connect the power cord of this machine to the same outlet as other products, use a commercially available noise filter or noise cut transformer.
- Use the power cord included in this machine, and plug the cord directly into the outlet. Do not use the power cords of other products for this machine.
- Do not use an extension cord. If you have to use an extension cord, use a cord rated 15A or higher.
- Use of an extension cord may result in this machine malfunctioning due to AC voltage drop.
- Do not turn this machine off or unplug the power cord during printing.
- If you do not use this machine for an extended period of time due to holidays, trips, or other reasons, unplug the power cord.
- Do not use the power cord included in this machine for other products.

1 Plug the power cord into the power connector.



2 Plug the power cord into the outlet.

Connecting a LAN Cable/USB Cable

When using the machine in a wired network connection or connecting to a computer via a USB cable, connect the cable in the following steps.

- Connecting a LAN Cable
- Connecting a USB Cable

Connecting a LAN Cable



A LAN cable (category 5e or higher, twist pair, straight) is not supplied.

- 1 Prepare a LAN cable (category 5e or higher, twist pair, straight) and hub.



- 2 Check that the machine and computer are turned off.
- 3 Open the interface cover on the back side of the machine pressing the center part of it.



- 4 Insert one end of the LAN cable into the network interface connector.

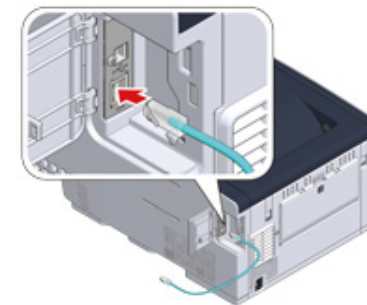

- 5** Pass the LAN cable under the tab, and then close the interface cover.

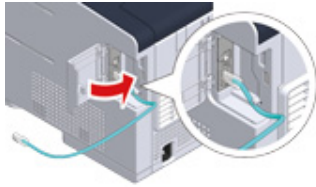

- 6** Insert the other end of the LAN cable into the hub.

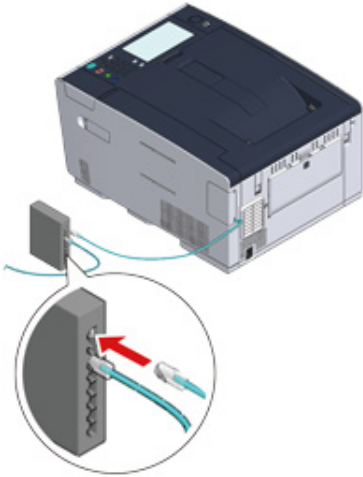

Go to the procedure to "Loading Paper in the Tray".

Connecting a USB Cable

A USB cable (Hi-Speed USB 2.0) is not supplied.

- 1** Prepare a USB cable.



If you want to connect in USB 2.0 Hi-Speed mode, use a Hi-Speed USB 2.0 USB cable.



- 2** Check that the machine and computer are turned off.
- 3** Open the interface cover on the back side of the machine pressing the center part of it.



- 4** Insert one end of the USB cable into the USB interface connector on the machine.



Do not insert the USB cable into the network interface connector. It may cause a malfunction.

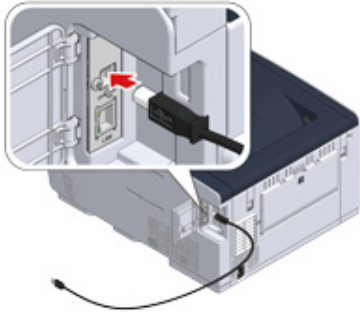

5 Pass the USB cable under the tab, and then close the interface cover.

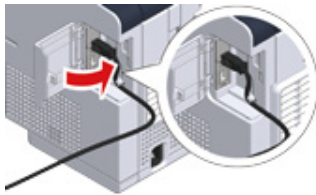

6 Insert the other end of the USB cable into the USB interface connector on the computer.



For Windows, do not insert the other end of the USB cable into the computer until the instruction is displayed on the screen when the driver installation is in progress.

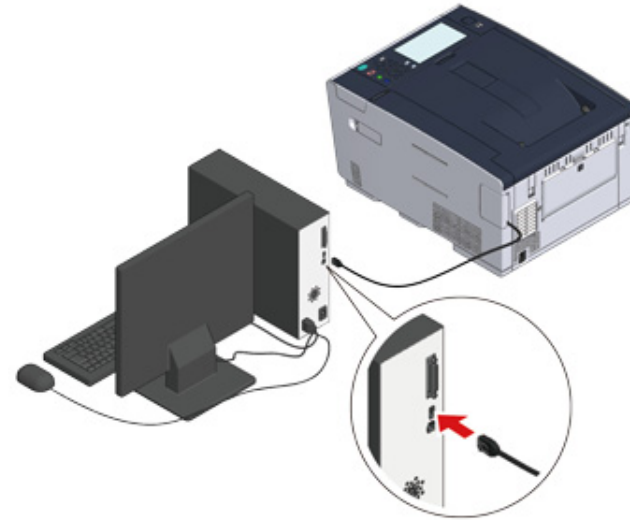

Go to the procedure to "Loading Paper in the Tray".

Loading Paper in the Tray

The procedure when loading paper in Tray 1 is used as an example.

The same procedure applies to Tray 2/3 (optional).

For details on available paper, see "About Paper Types That Can be Loaded".

- 1 Pull the paper cassette out.



- 2 Slide the paper guide (a) to the width of paper to be loaded.

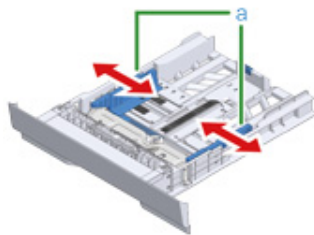

- 3 Slide the paper stopper (b) to the length of paper to be loaded.

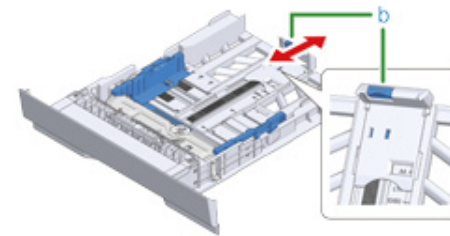

- 4 Fan a stack of paper well, and then align the edges of the paper.

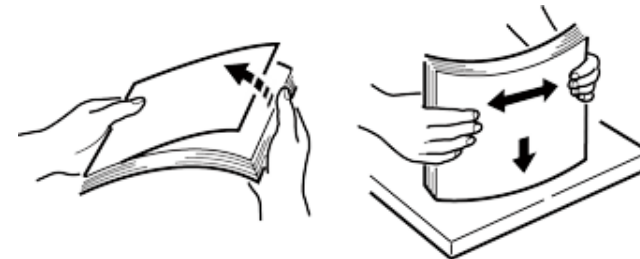

- 5 Load paper with the print side face down.



Do not load paper above the "▽" mark on the paper guide.

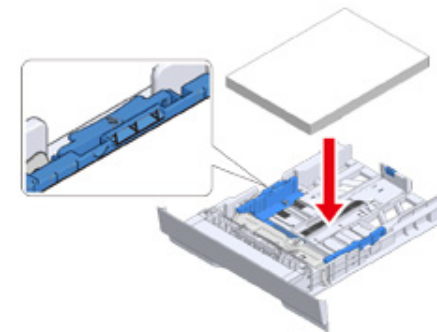

- 6 Secure the loaded paper with the paper guide.

- 7 Replace the paper cassette into the machine.
Push the paper cassette until it stops.



Setting Up This Machine

The first time the machine is turned on or when the settings are initialized, [Easy Setup] is displayed. Follow the on-screen instructions to set required information. You can skip the setting pressing [Skip>>].



The simplest steps are shown here.

- Language Setup
- Setting Date and Time
- Setting the Administrator Password
- Network Settings
- Test Print

Language Setup

- 1 Press the power switch on the operator panel for a second to turn the machine on.

When the machine is turned on, the power switch LED lamp turns on.



- 2 When the language selection screen in [Easy Setup] is displayed, press the language you want to use.



Press [▲][▼] to switch screens.

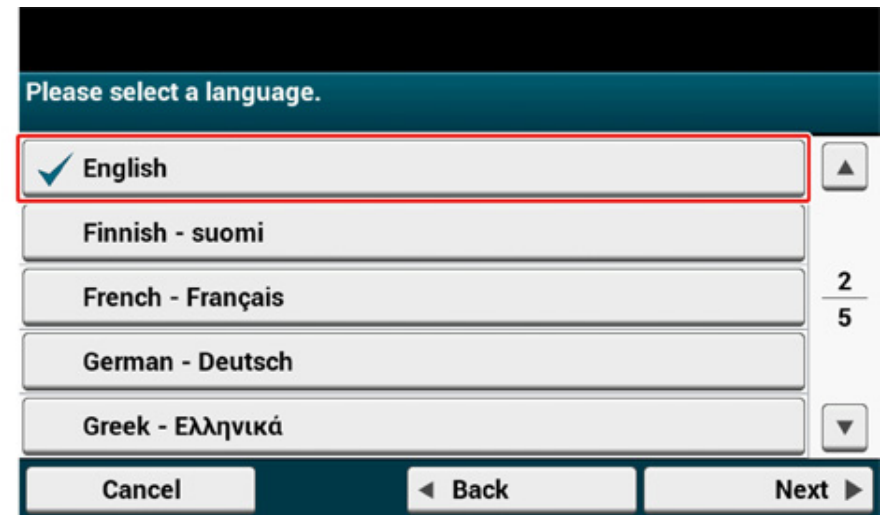

- 3 Select the desired keyboard layout.

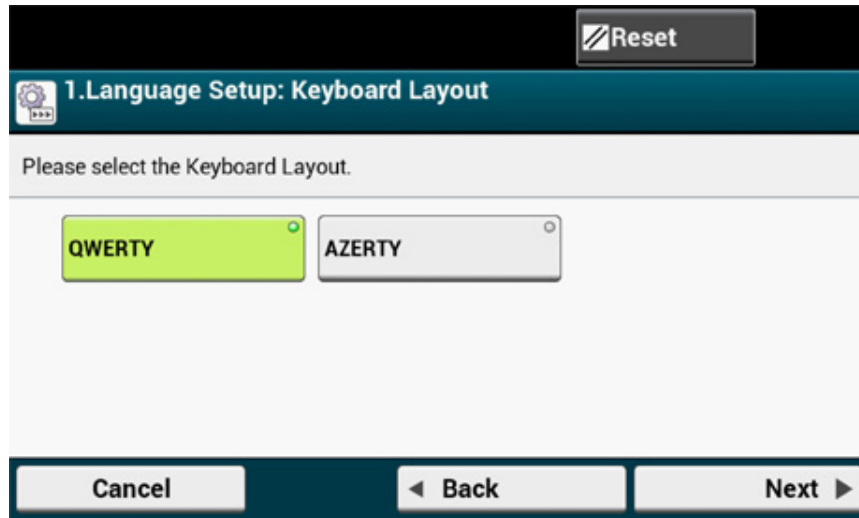

- 4 Press [Close].



The screen switches automatically in about 7 seconds without pressing [Close].

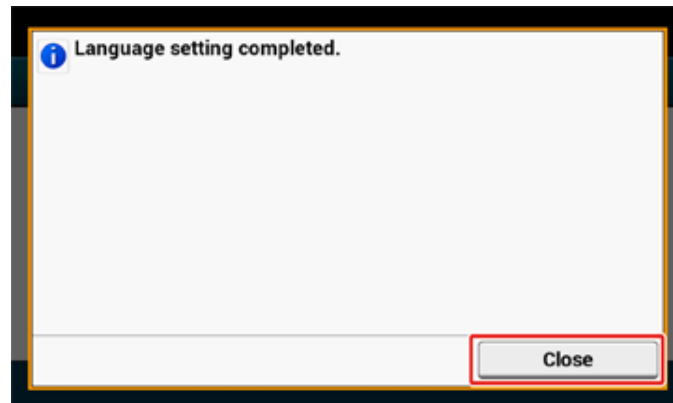

- 5 Press [Continue with default settings].

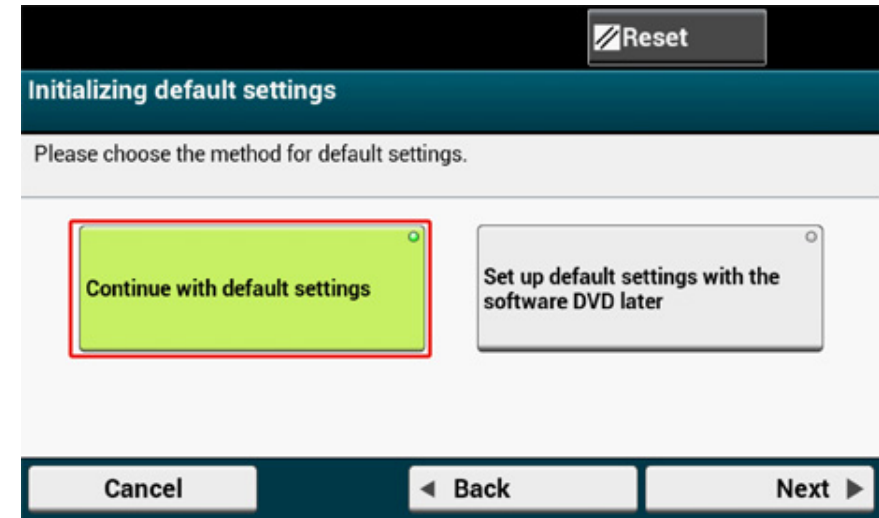

- 6 Check that the consumables and wiring are set up, and then press [Next].

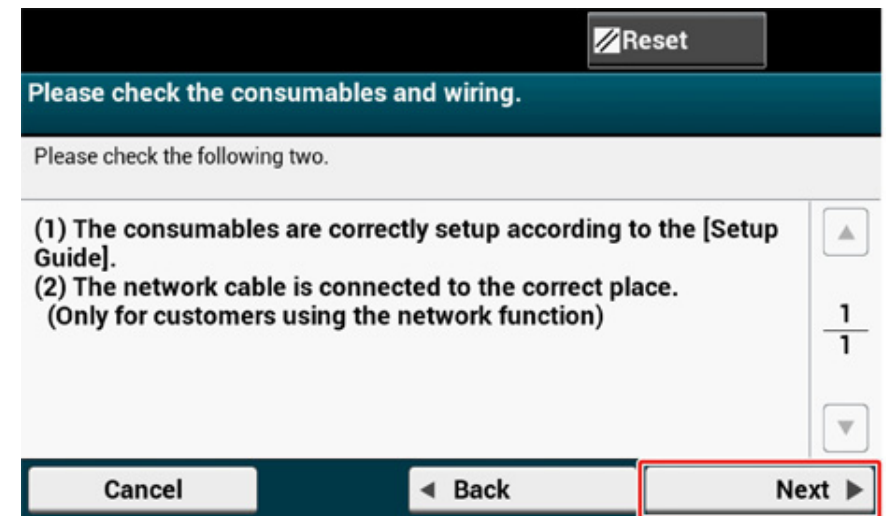

Setting Date and Time

- 1 Check that the [2. Date/Time Setting] screen is displayed, and then press [Next].

The time zone setting screen appears.

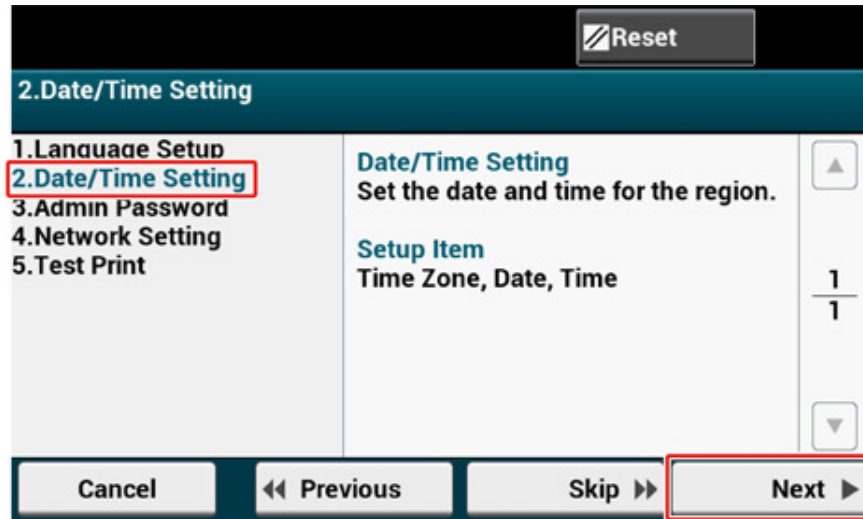

- 2 Press [Select] for the time zone you want to use.



Press [▲][▼] to switch screens.

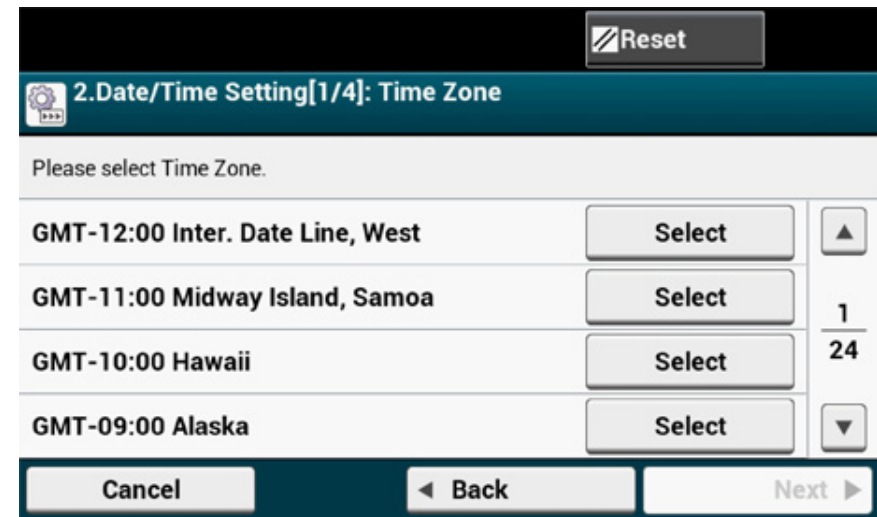

- 3 Press [Manual].

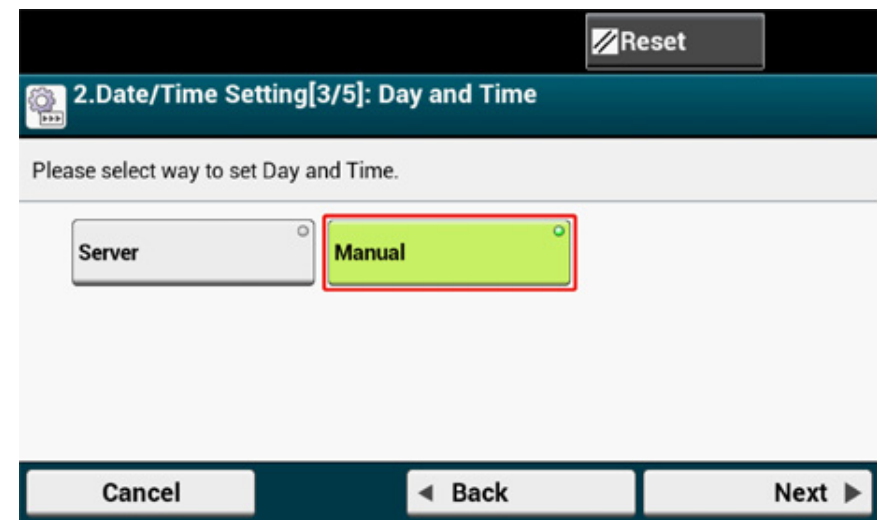

- 4 Enter the month using [▲][▼] or the numeric keypad on the operator panel. Use the numeric keypad on the operator panel to enter a value in the field with the  (numeric keypad) icon.

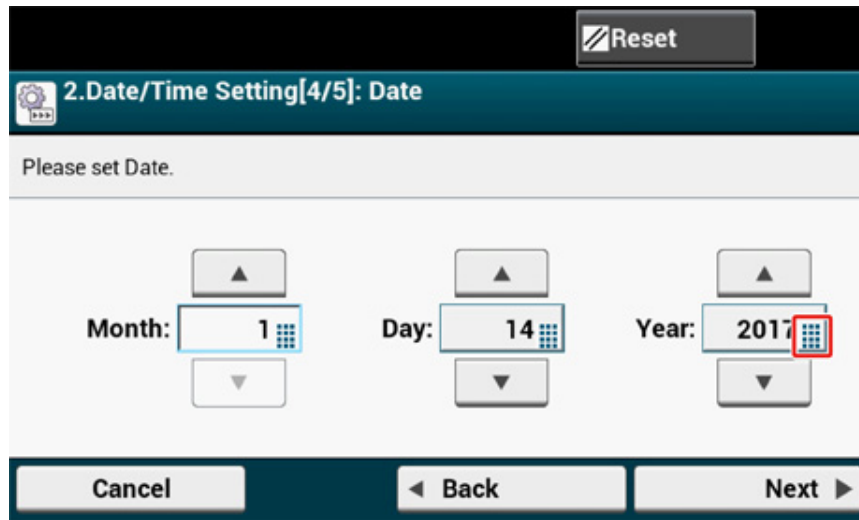

- 5 Press the [Day] entry box once to enter the day.
- 6 Press the [Year] entry box once to enter the year, and then press [Next].

- 7 Use [▲][▼] or the numeric keypad on the operator panel to enter the current time in the same manner as the date entry, and then press [Next]. The setting values are updated.

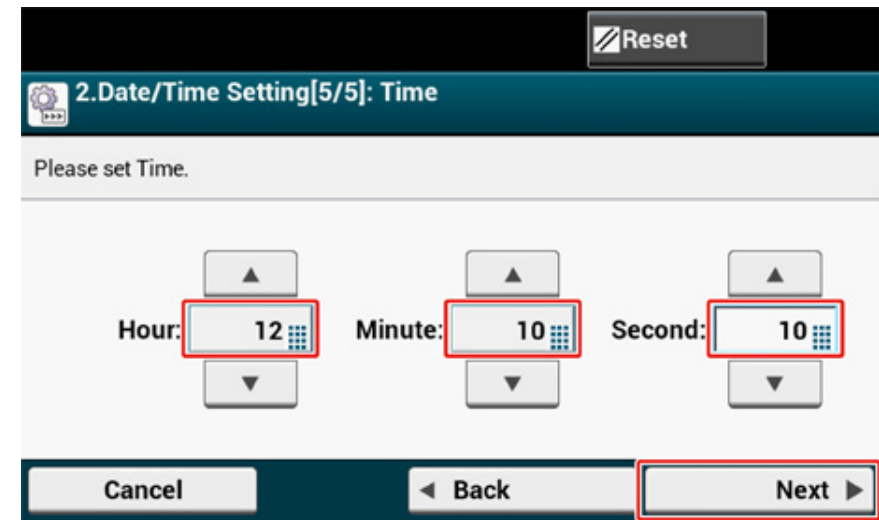

- 8 Press [Close].



The screen switches automatically in about 7 seconds without pressing [Close].

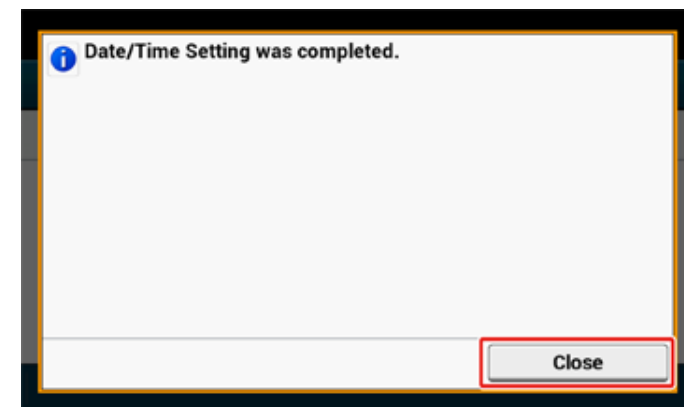

Setting the Administrator Password



The factory default administrator password is “999999”, however, we highly recommend you to set your own administrator password so that the third party cannot easily presume it.

- 1 Check that the [3. Admin Password] screen is displayed, and then press [Next].

The setting a new administrator password screen appears.

- 2 Enter a new administrator password and press [Next].



- We suggest you to write down the set password not to forget it.
- The administrator password is required when changing the settings, etc.
- Note that if you forgot or lost your administrator password, you could not change the [Admin Setup] or [Easy Setup] settings.



- Set the administrator password using from 6 to 12 alphanumeric characters.
- The password is case sensitive.

- 3 Enter the password again to confirm.

- 4 Press [Next].
The setting values are updated.

- 5 Press [Close].



The screen switches automatically in about 7 seconds without pressing [Close].

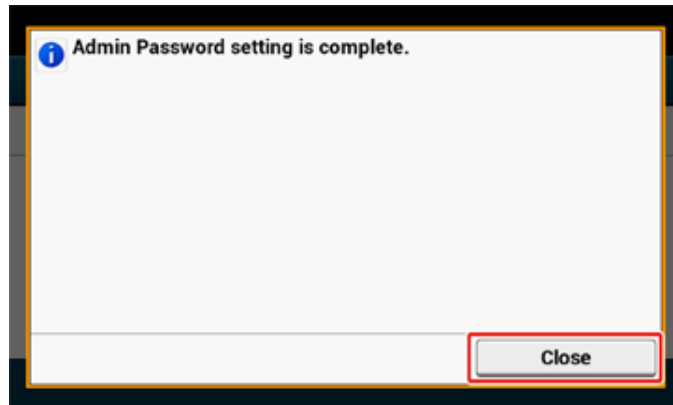

Network Settings



- If you do not want to connect to a network, press [Skip>>] to go to "Test Print".
- Since the network settings are required when using this machine, you are supposed to make the network setting here.

- 1 Check that the [4. Network Setting] screen is displayed, and then press [Next] for the connection with a LAN cable.

For the wireless connection, you do not need to make the network settings here. Press [Skip>>] and go to "Test Print". The wireless connection settings are to be performed after [Easy Setup] is finished.

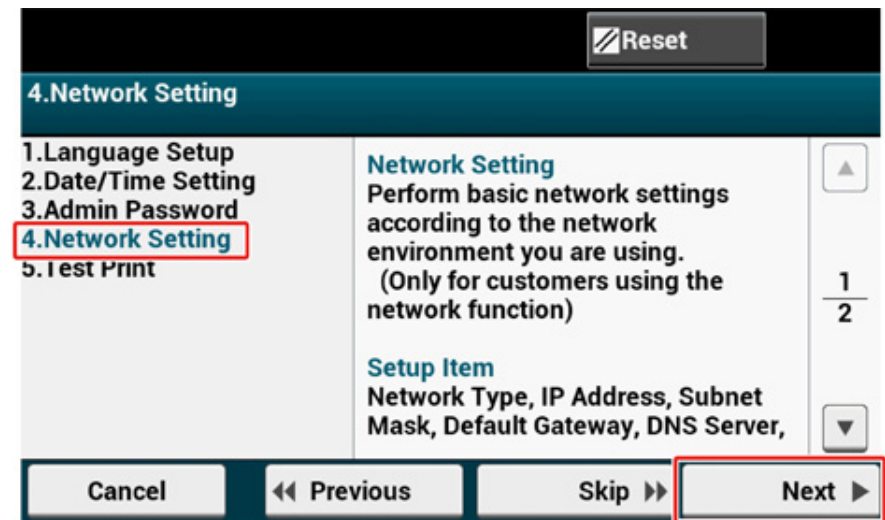

- 2 Check that the wiring has correctly been finished.
- 3 Set an IP address. Press [Auto].



When setting manually, check the following values specified by your provider or network administrator.

IP Address

Subnet Mask

Default Gateway

DNS Server (Primary)

DNS Server (Secondary)

WINS Server (Primary)

WINS Server (Secondary)

- 4 Press [Close] on the following screen which is displayed after the setting is updated.



- Wait until updating the setting is complete.
- The screen switches automatically in about 7 seconds without pressing [Close].

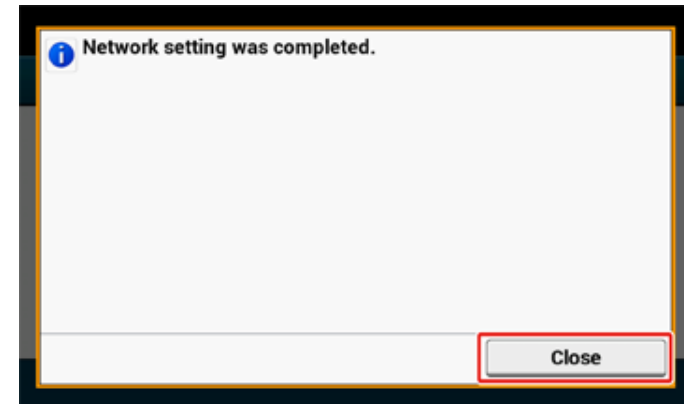

Test Print



If you do not want to print test page, press [Skip>>]. The Easy Setup is complete and the home screen appears.

- 1 Check that the [5.Print Test] screen is displayed, and then press [Next].
The Print Test screen is displayed.

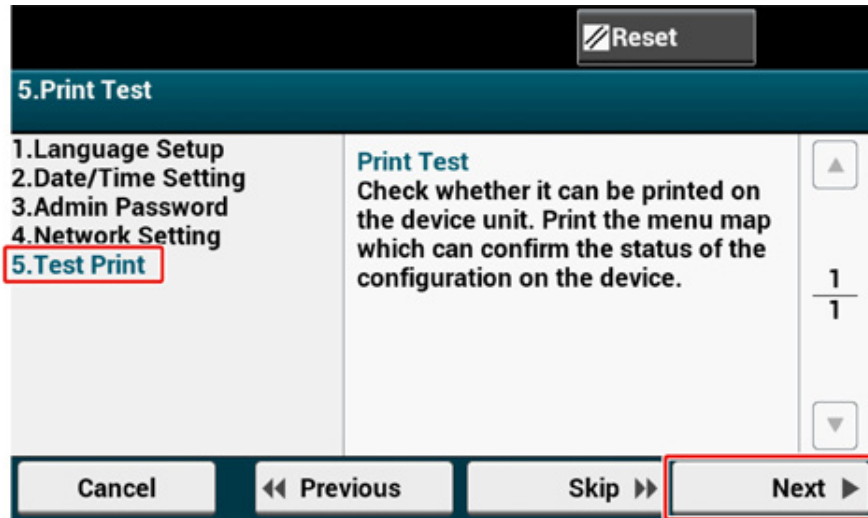

- 2 Click [Print Test].

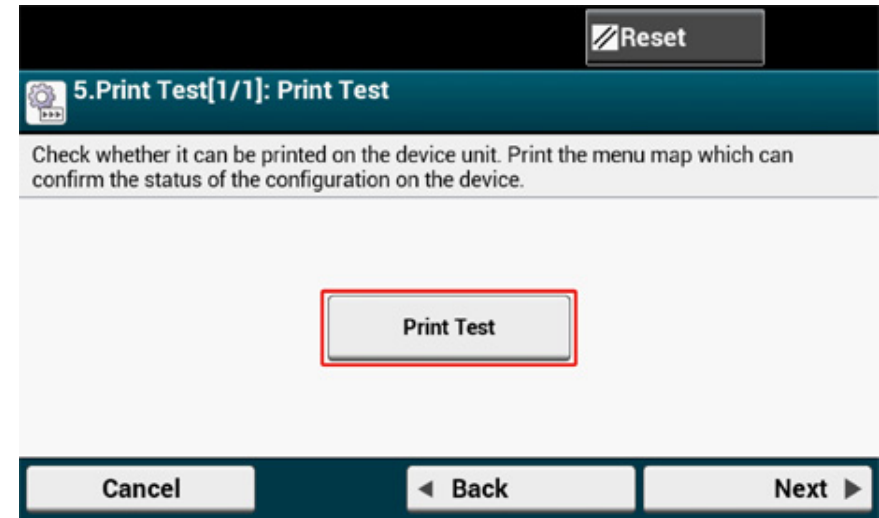

- 3 Press [Yes].

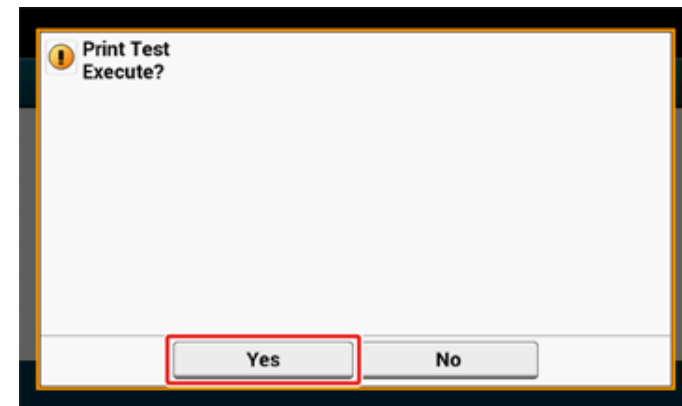

- 4 Check that the menu map is printed, and then press [Close].

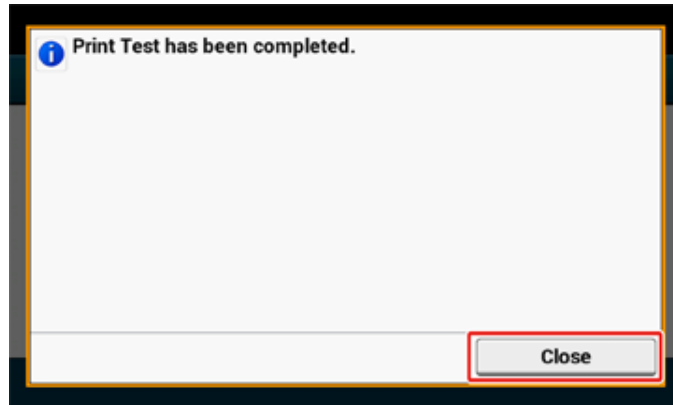

- 5 Press [Complete].

The Easy Setup is complete and the home screen appears.



You can change the settings from [Device Settings] > [Easy Setup] at the top of the home screen whenever you want.

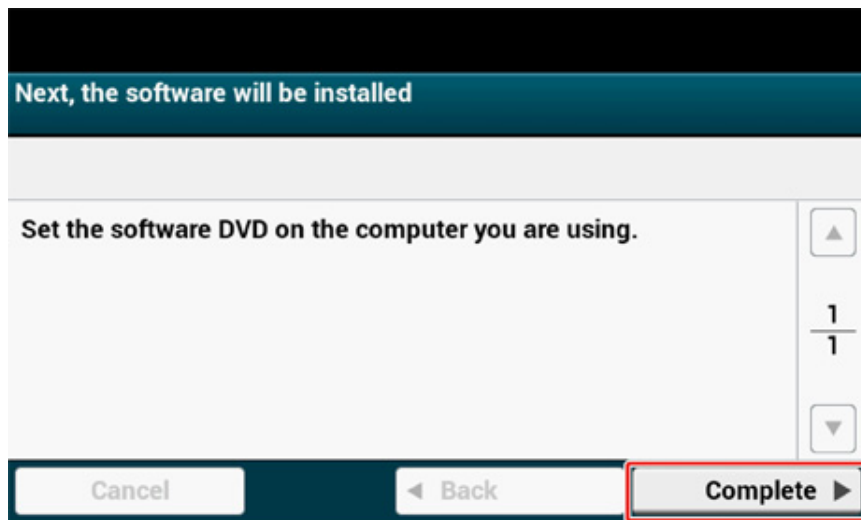

Connecting to a Wireless LAN (Only When the Wireless LAN Module is Mounted)

- Before Connecting to a Wireless LAN
- Enabling Wireless LAN Connection
- Connecting to an Access Point (Infrastructure)
- Connecting to the Machine Directly

Before Connecting to a Wireless LAN



- Wireless(Infrastructure) and Wireless(AP Mode) cannot be enabled at the same time.
- If the machine is used in a wireless network environment, the machine does not enter Deep Sleep mode but enters Sleep mode.
- Do not place any electric products that emit weak radio waves (such as microwaves or digital cordless telephones) close to the machine.
- The communication speed of a wireless LAN connection may be slower than that of a wired LAN or USB connection depending on the environment. If you want to print big data such as a photo, it is recommended to print with a wired LAN or USB connection.

Connecting to an Access Point

Connect this machine to a network via a wireless LAN access point.



- 1 Check if your wireless LAN access point matches the following requirements.

Standards: IEEE 802.11 a/b/g/n

Access method: Infrastructure mode

2 Check if the wireless LAN access point supports WPS.

If it does not support WPS, check the SSID and encryption key by referring to the instruction manual that is included in the wireless LAN access point or other documents.



- An SSID is also called a network name, ESSID or ESS-ID.
- An encryption key is also called a network key, security key, password, or Pre-shared Key.

Connecting to the Machine Directly

You can use the machine as a wireless access point to directly connect wireless devices (computers, tablets, smartphones, etc.). Check the following.

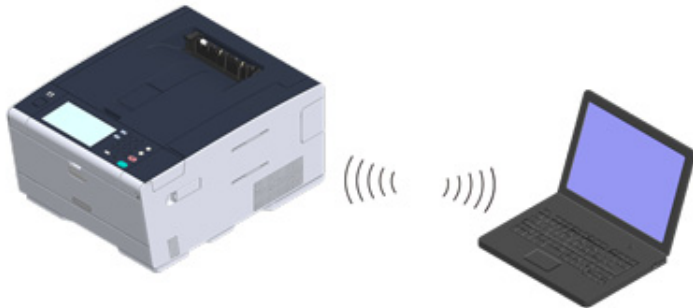

1 Check if your wireless devices match the following requirements.

Standards: IEEE 802.11 b/g/n
Security: WPA2-PSK(AES)

2 Check if your wireless devices support WPS-PBC (push button).



If you are not sure that the device supports WPS-PBC, connect manually after turning the machine on.

Enabling Wireless LAN Connection

- 1 Check that the machine is turned on.
- 2 Press [Device Settings] at the top of the home screen.

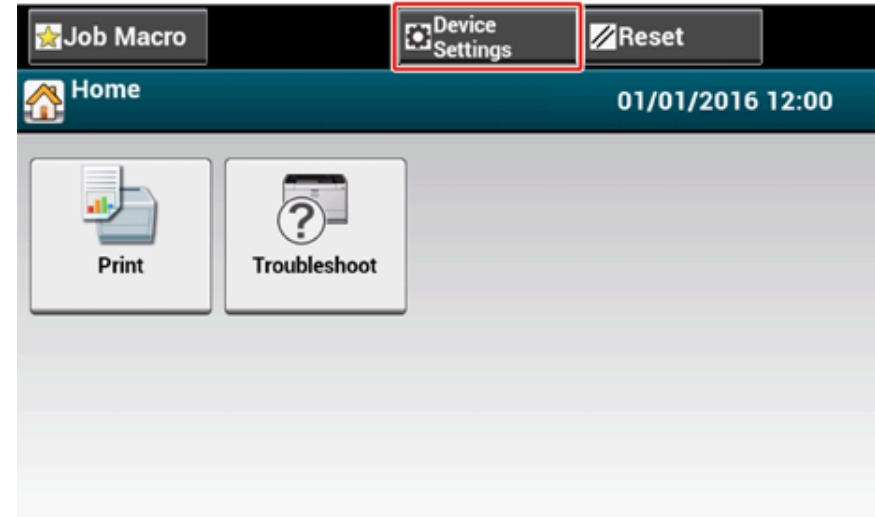

- 3 Press [**▲**] once and press [Admin Setup].

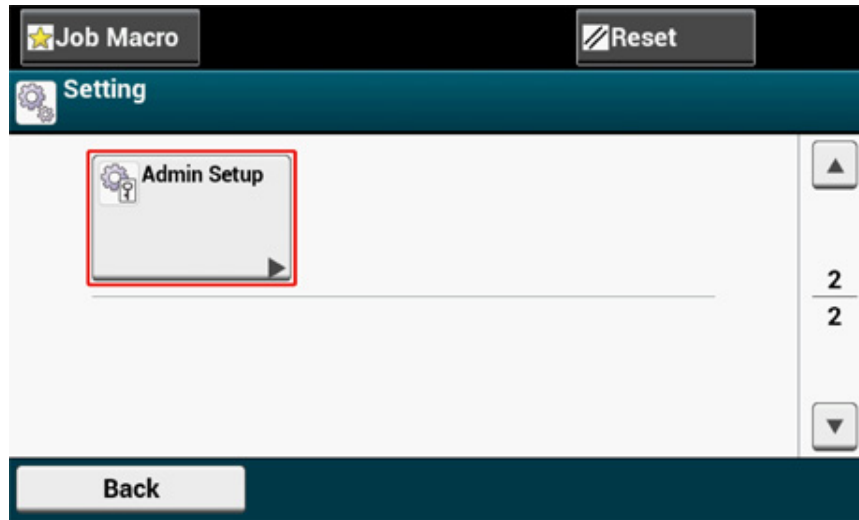

- 4 Enter the administrator password, and then press [OK].



The factory default administrator name and password are "admin" and "999999" respectively. If the administrator password is changed in Easy Setup, enter the updated password.

 A screenshot of the 'Administrator Login' screen. It has a title bar with an information icon and the text 'Administrator Login Enter the Admin Name and Admin Password and press [OK]'. There are two input fields: 'Admin Name' with 'admin' entered, and 'Admin Password' with '---No Setting---' entered. The 'Admin Password' field is highlighted with a red rectangle. To the right, there is a section for 'Authentication Type: Local' and an 'Authentication Method' dropdown menu. At the bottom are 'Cancel' and 'OK' buttons.

- 5 On the administrator login screen, press [OK].

- 6 Press [**▲**] once and press [User Install].

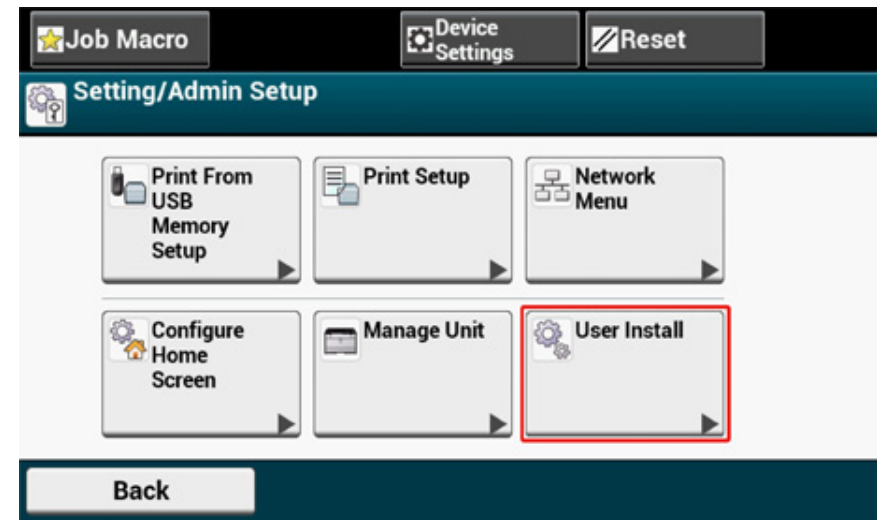

- 7 Press [**▲**] once and press [Wireless Module].

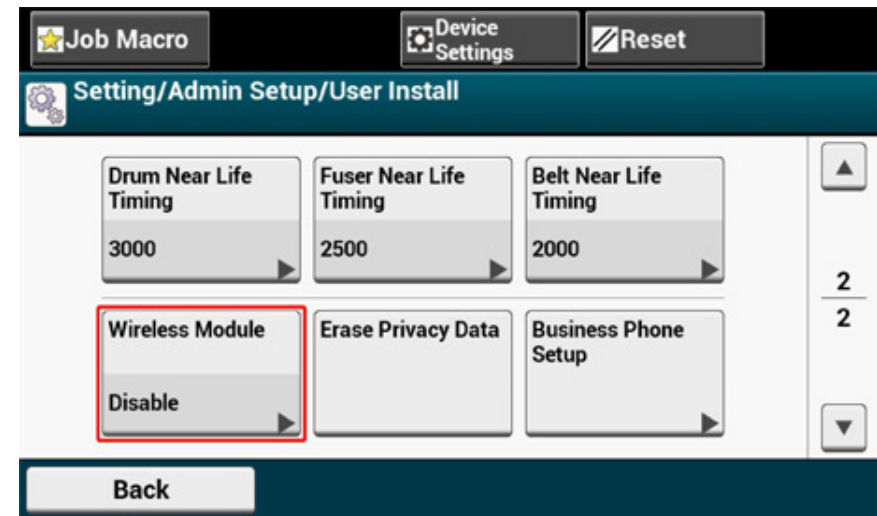

8 Press [ENABLE].

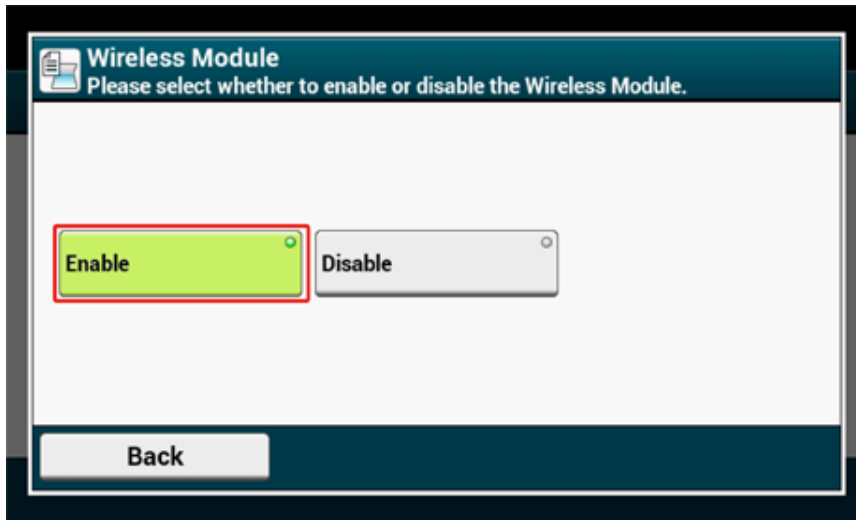

9 Press [Back] until the home screen is displayed.

10 Press the power button to turn the machine off.

11 Press the power button to turn the machine on.

12 Press "Yes" if "Do you want to Set-up wireless?" is displayed on the touch panel.

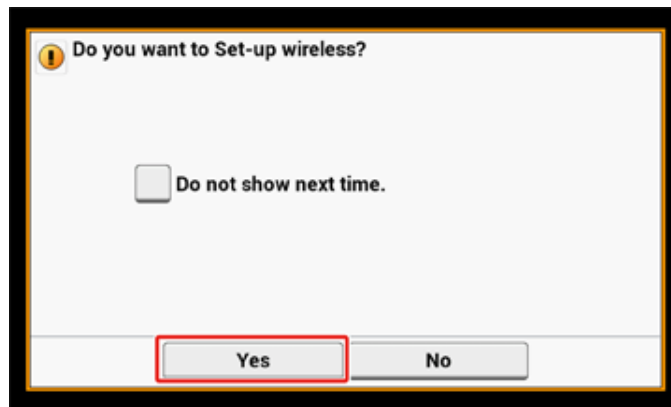

And then go to "Connecting to an Access Point (Infrastructure)".

Connecting to an Access Point (Infrastructure)



- Install this machine in a place with a good view and near a wireless access point. (We suggest that the distance between the machine and the wireless device be 30 m or less.)
- If there is metal, aluminum sash, or a reinforced concrete wall between the machine and wireless LAN access points, connections may be harder to be established.
- Outdoor use of IEEE802.11a (W52/W53) is prohibited by the Radio Law. Use IEEE802.11a (W52/W53) only indoors.

• Connecting with WPS

If a wireless LAN access point supports WPS, you can connect to the wireless LAN with the WPS button.

• Selecting a Wireless LAN Access Point from the Operator Panel to Connect

If a wireless access point does not support WPS, you can specify a wireless LAN access point you want to use from the wireless LAN access points that the printer detects to establish a connection.

• Setting from the Operator Panel Manually to Connect

Set the wireless LAN access point information (the SSID, encryption method, and encryption key) manually to connect to the wireless LAN.

Connecting with WPS

If a wireless LAN access point supports WPS, you can easily connect to the wireless LAN with the easy setup button (WPS button).

Connect by following the procedure below.

- 1 Check the position of the WPS button by referring to the instruction manual that is included in a wireless LAN access point or other document.
- 2 Check that the wireless LAN access point starts and is operating properly.
- 3 Turn the machine on.



If the following screen is displayed, press [Yes], and then proceed to step 6.

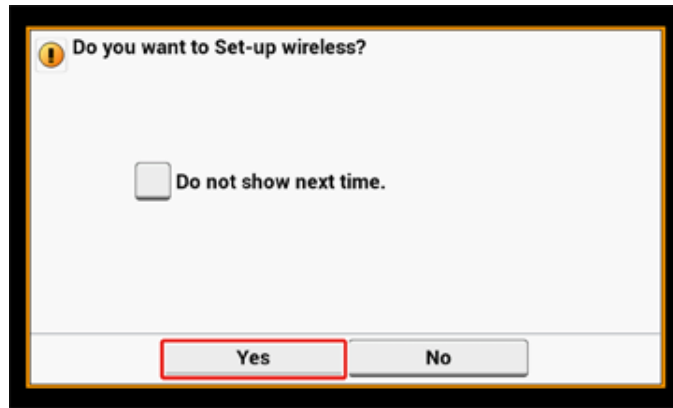

- 4 Press [Device Settings] on the touch panel.
- 5 Press [\blacktriangle] once and press [Wireless(Infrastructure) Setting].

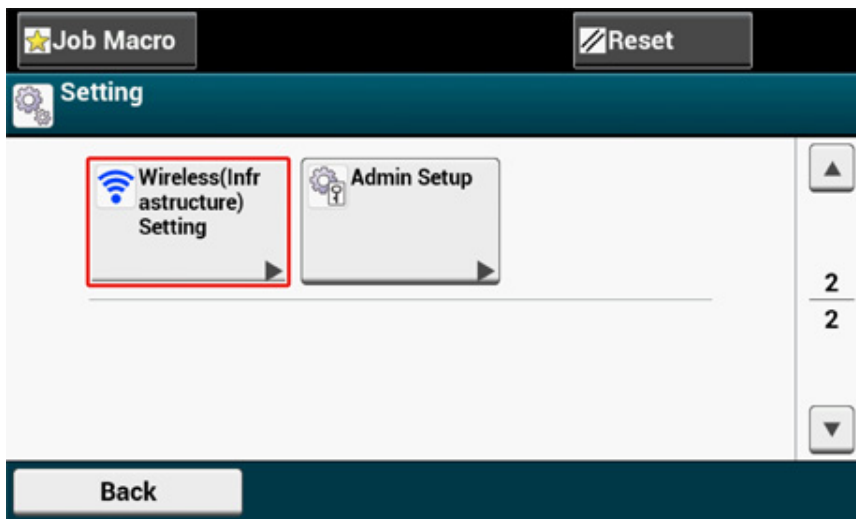

- 6 Enter the administrator name and password and press [OK].
The factory default administrator name and password are "admin" and "999999" respectively.

The following message is displayed for approximately 5 seconds.

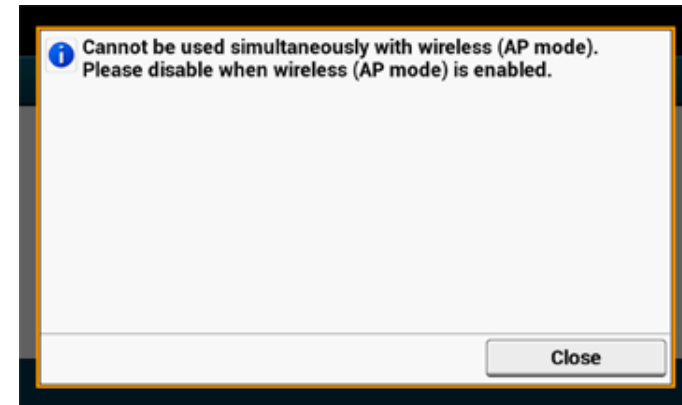

- 7 Press [Enable].

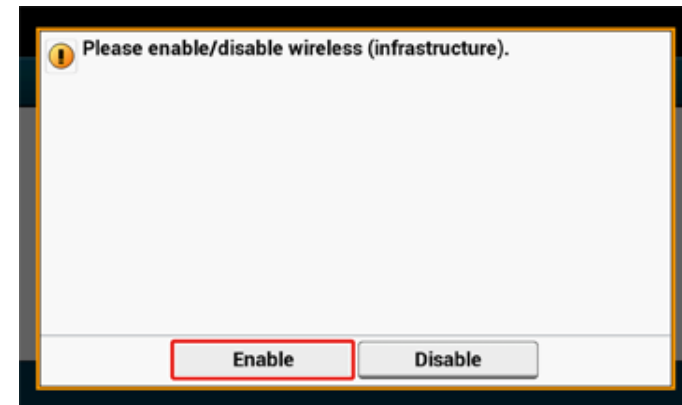

- 8 If your environment requires to set IP address, etc. manually, press [Network Setting]. If you do not need to set manually, go to step 12.

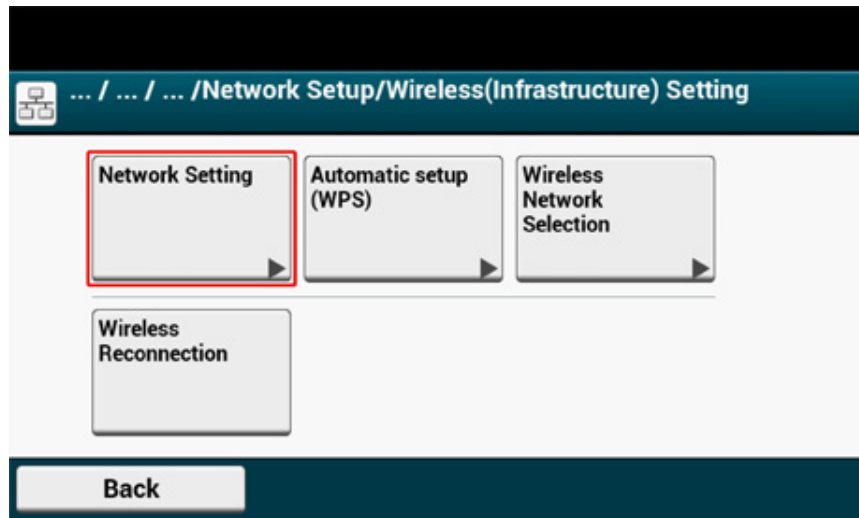

- 9 Press [Manual] on the [Wireless (infrastructure) settings] screen.

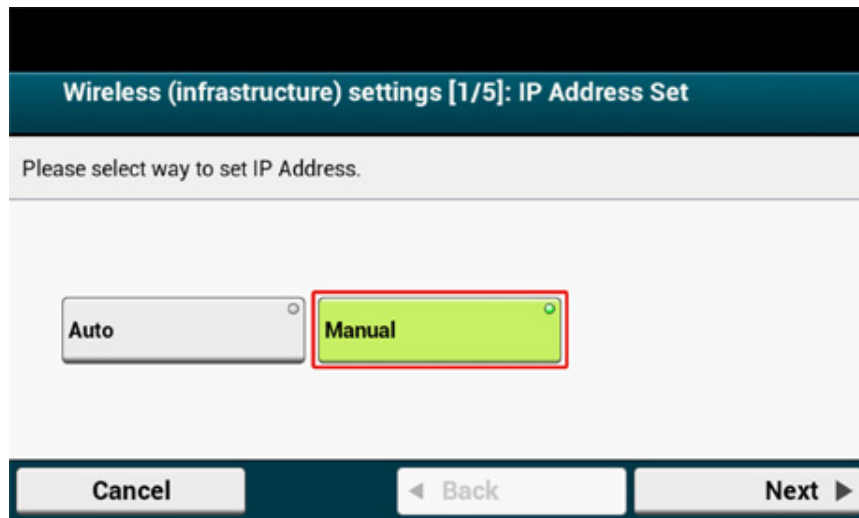

- 10 Follow the onscreen instructions to set the IP address, subnet mask, default gateway, and DHCP v6.



Ask your provider or network administrator about the setting value.

- 11 Press [Close] when the Wireless (infrastructure) settings are complete.



The screen switches automatically in a while without pressing [Close].

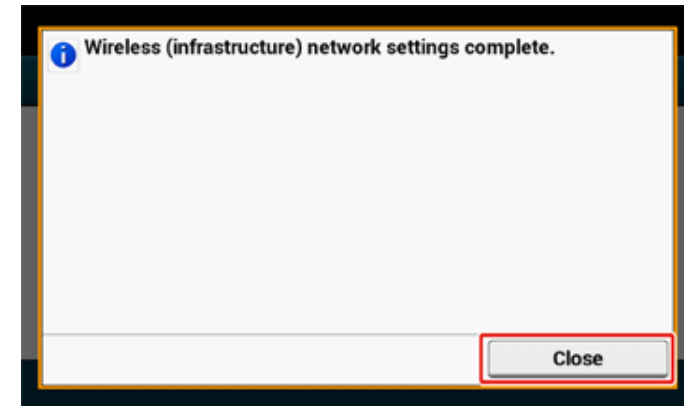

- 12 Press [Automatic setup (WPS)].

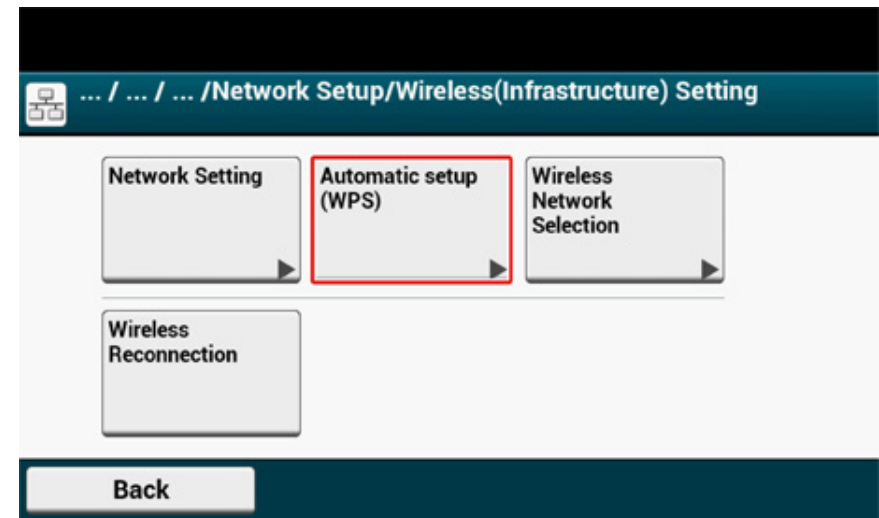

13 Press [WPS-PBC].

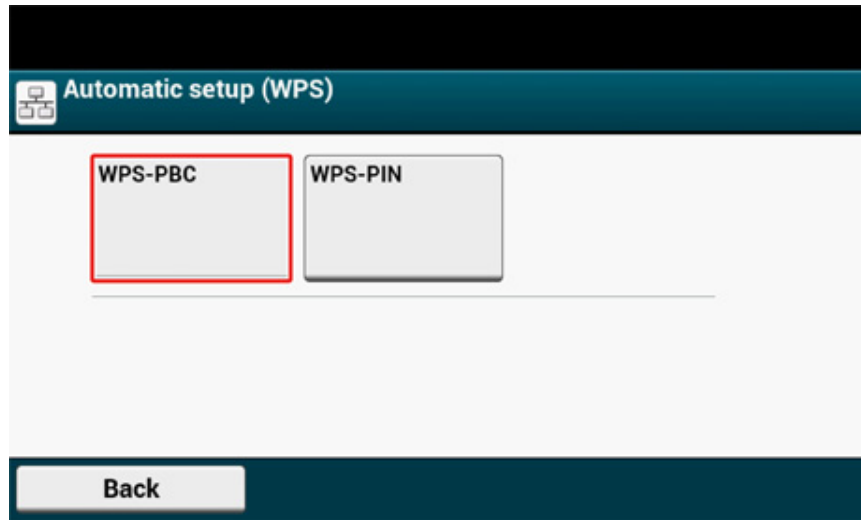

14 Press [Yes].

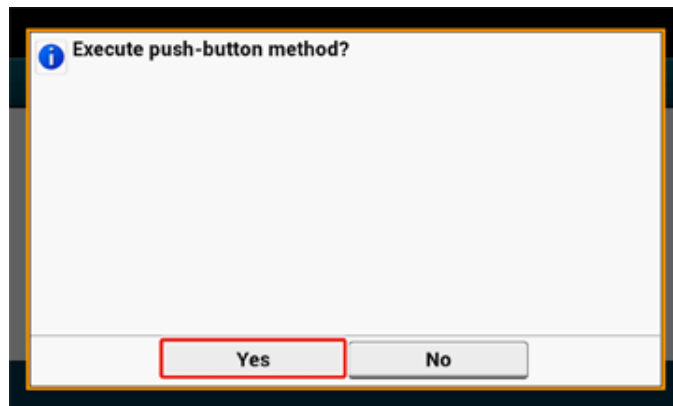

The machine starts searching for wireless LAN access points. The following screen is displayed for approximately 2 minutes, during which press and hold the WPS button for the wireless LAN access point for a few seconds.

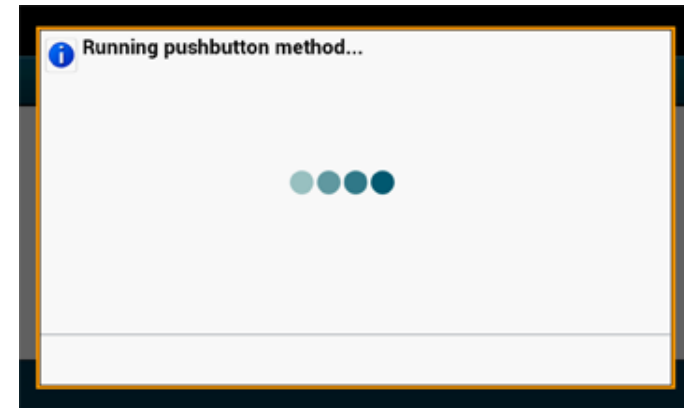

You cannot operate the panel when WPS is in progress.

When the following screen is displayed, press [Close].

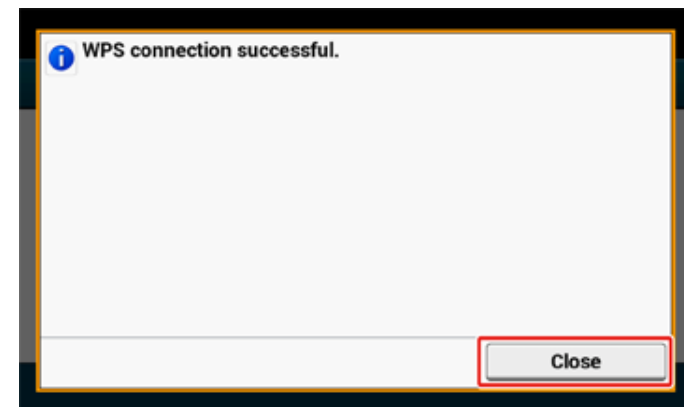



- If the following screen is displayed, repeat the procedure from step 13.

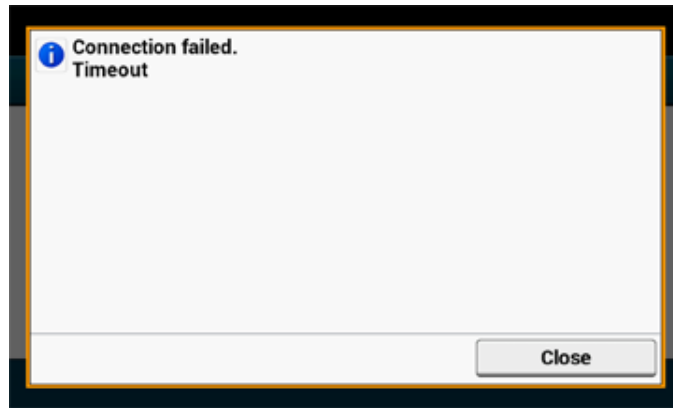

- [Overlap] is displayed when multiple WPS push buttons are pressed almost at the same time at two or more wireless LAN access points and connection is not established. Wait for a while, and then try again.

- 15** If the antenna mark is displayed at the top right of the home screen, the connection is established correctly.

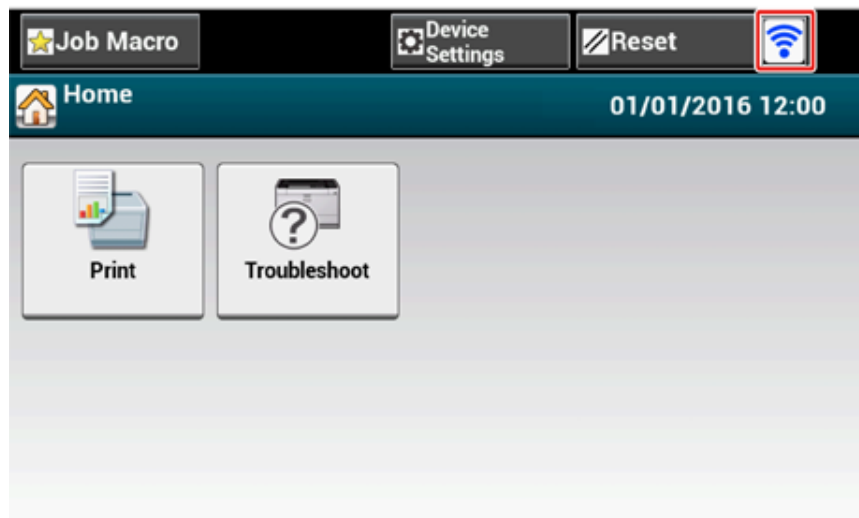

The antenna mark may not be displayed on some screen.

Selecting a Wireless LAN Access Point from the Operator Panel to Connect

If a wireless LAN access point does not support WPS, you can specify a wireless LAN access point you want to use from the wireless LAN access points that the machine detects to establish a connection. In such a case, you must enter an encryption key.

- 1 Check the SSID and encryption key by referring to the instruction manual that is included in a wireless LAN access point or other documents, and write the information down.



WPA-EAP and WPA2-EAP cannot be set on the touch panel. Set them from the Web page of this machine.



Open the Web Page of This Machine (Advanced Manual)



- An SSID is also called a network name, ESSID or ESS-ID.
- An encryption key is also called a network key, security key, password or Pre-shared Key.

- 2 Check that the wireless LAN access point starts and is operating properly.
- 3 Turn the machine on.



If the following screen is displayed, press [Yes], and then proceed to step 6.

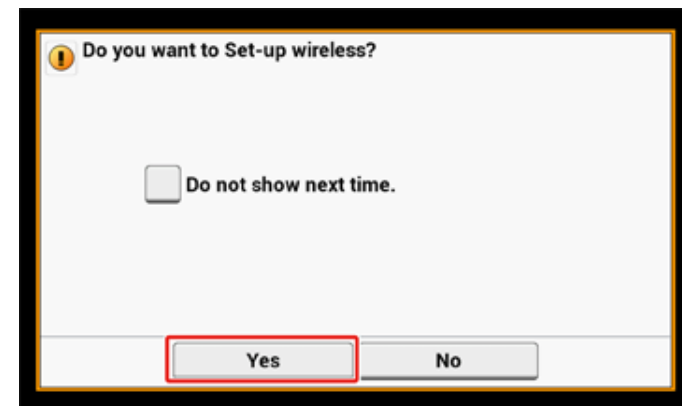

- 4 Press [Device Settings] on the touch panel.

5 Press [Wireless(Infrastructure) Setting].

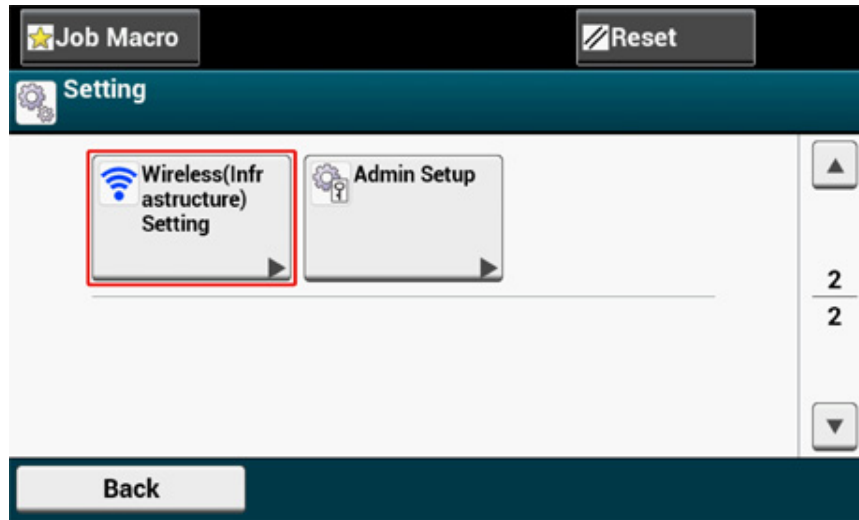

6 Enter the administrator name and password and press [OK].

The factory default administrator name and password are "admin" and "999999" respectively.

The following message is displayed for approximately 5 seconds.

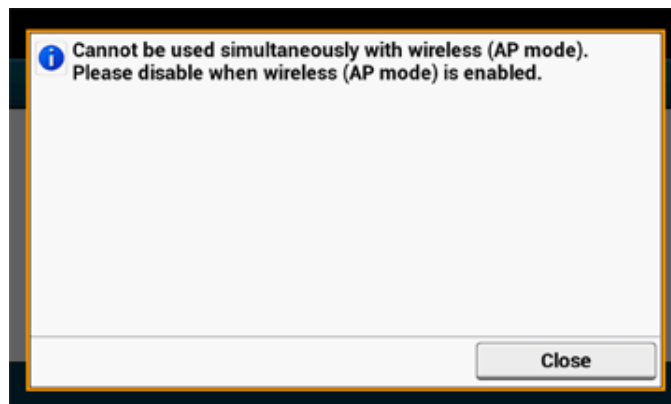

7 Press [Enable].

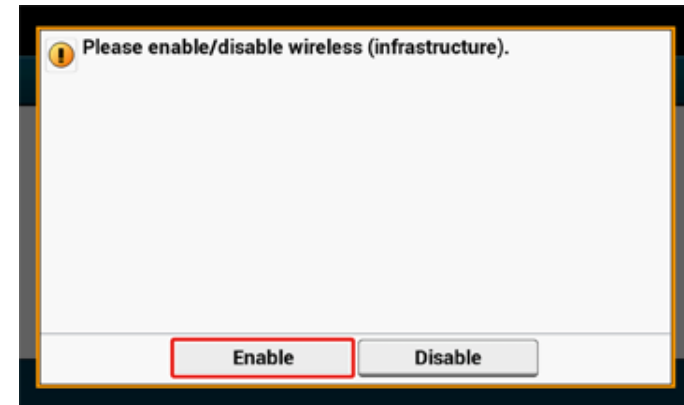

8 If your environment requires to set IP address, etc. manually, press [Network Setting]. If you do not need to set manually, go to step 12.

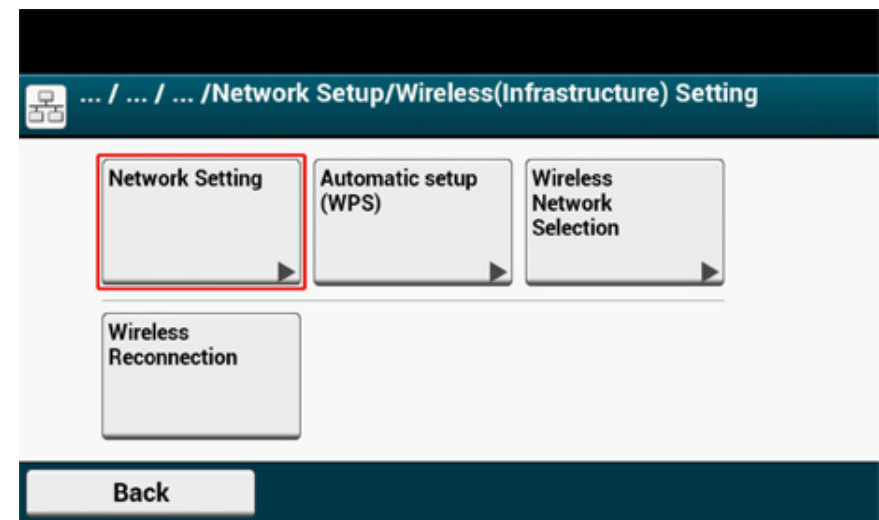

- 9 Press [Manual] on the [Wireless (infrastructure) settings] screen.

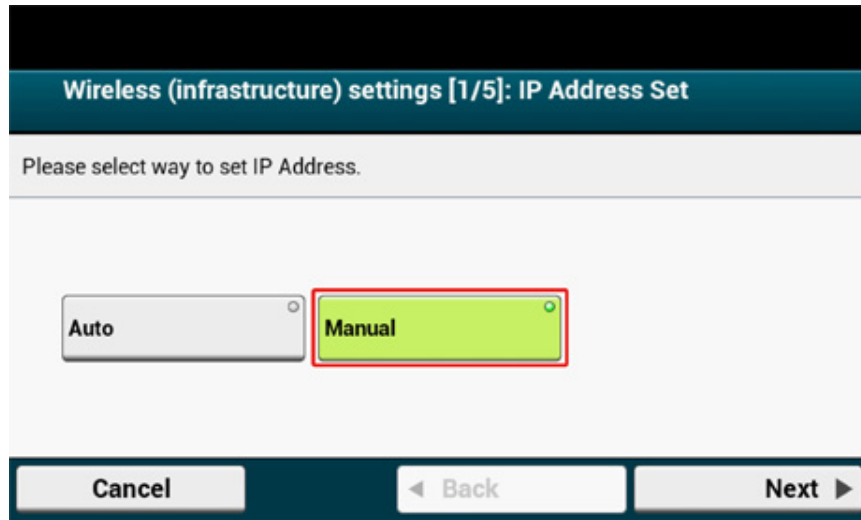

- 10 Follow the onscreen instructions to set the IP address, subnet mask, default gateway, and DHCP v6.



Ask your provider or network administrator about the setting value.

- 11 Press [Close] when the Wireless (infrastructure) settings are complete.



The screen switches automatically in a while without pressing [Close].

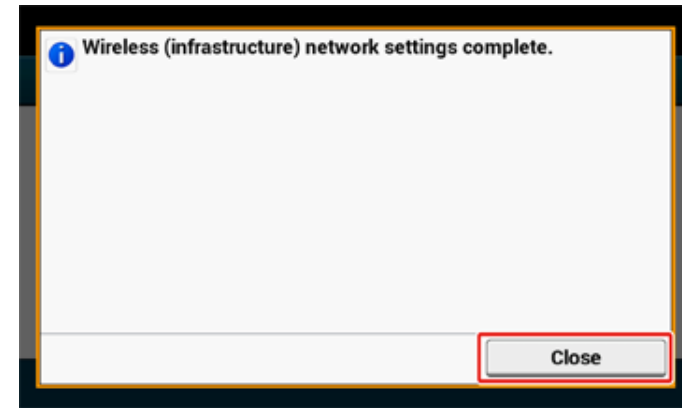

- 12 Press [Wireless Network Selection].

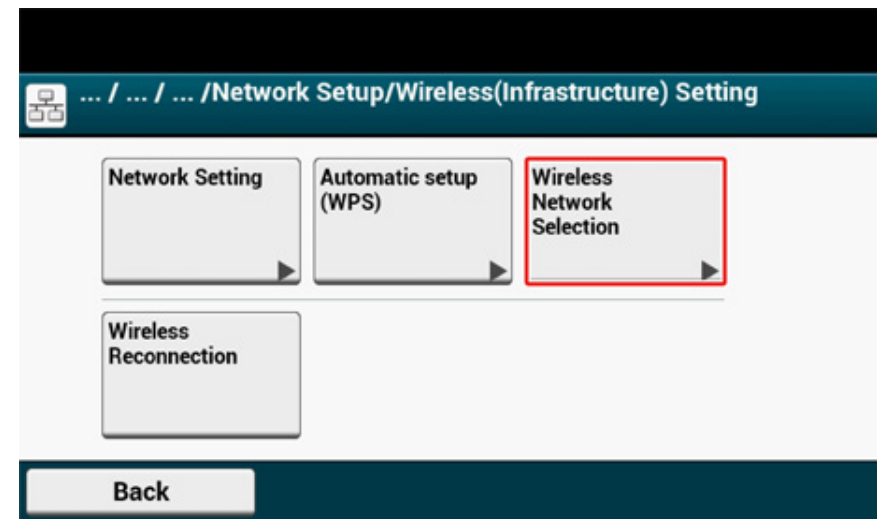

The machine starts searching for wireless LAN access points. Wait for a while.

- 13 Select a wireless LAN access point to connect, and then press [Select].

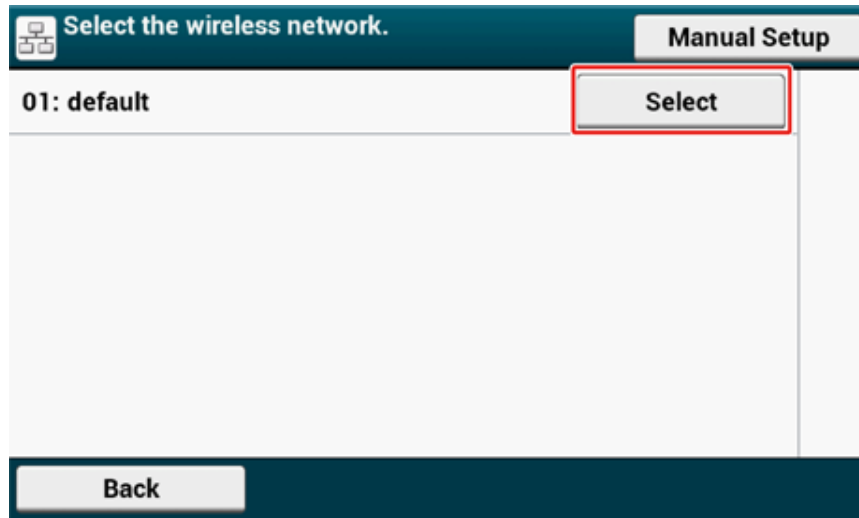

If only [Manual Setup] is displayed, or the SSID of the wireless LAN access point you want to use is not included in the list, set by following the procedure in "Setting from the Operator Panel Manually to Connect".

The encryption key entry screen that is suitable for the encryption method of the selected wireless LAN access point is displayed.

- 14 Enter the encryption key that you checked in step 1, and then press [OK].



The encryption key varies depending on the wireless LAN access point or security.

- If the [WPA Pre-shared Key] message is displayed

Item	Description
Security	WPA/WPA2-PSK
Encryption key	Enter the Pre-shared Key.

- If [WEP Key] is displayed

Item	Description
Security	WEP
Encryption key	Enter the WEP key.

- If neither of the above two cases is applied

Item	Description
Security	Disable
Encryption key	No entry is required.

- 15 If the displayed SSID is the same as the SSID that you checked in step 1, press [Yes].

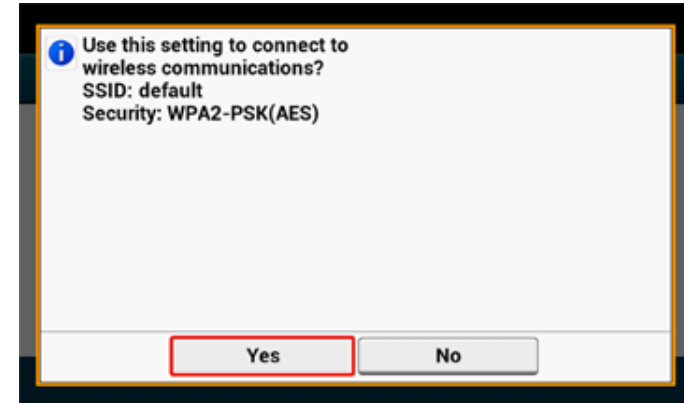

When "Connection successful." is displayed, press [Close].

If "Connection failed." is displayed, repeat the procedure from step 5.

- 16 If the antenna mark is displayed at the top right of the touch panel, the connection is established correctly.

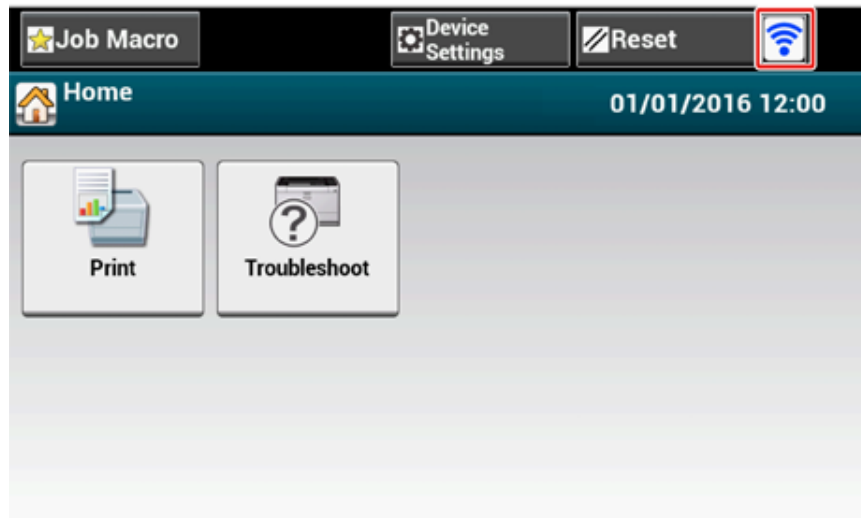

The antenna mark may not be displayed on some screens.

Setting from the Operator Panel Manually to Connect

Set the wireless LAN access point information (the SSID, encryption method and encryption key) manually to connect to the wireless LAN.

- 1 Check the SSID, encryption key, and security by referring to the instruction manual that is included in a wireless LAN access point or other documents, and write the information down.



If the encryption method is WPA-EAP and WPA2-EAP, set from the Web page of this machine.

For details, open the Web page of this machine and click [Admin Setup] > [Network] > [Wireless Setting] > [Manual Setup].

 Open the Web Page of This Machine (Advanced Manual)



- An SSID is also called a network name, ESSID, or ESS-ID.
- An encryption key is also called a network key, security key, password, or Pre-shared Key.

- 2 Check that the wireless LAN access point starts and is operating properly.
- 3 Turn the machine on.



If the following screen is displayed, press [Yes], and then proceed to step 6.



- 4 Press [Device Settings] on the touch panel.

5 Press [Wireless(Infrastructure) Setting].

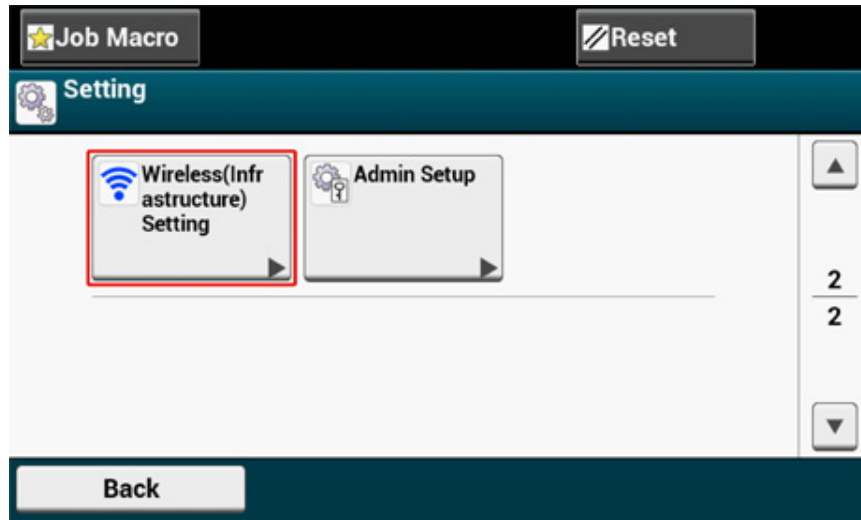

6 Enter the administrator name and password and press [OK].

The factory default administrator name and password are "admin" and "999999" respectively.

The following message is displayed for approximately 5 seconds.

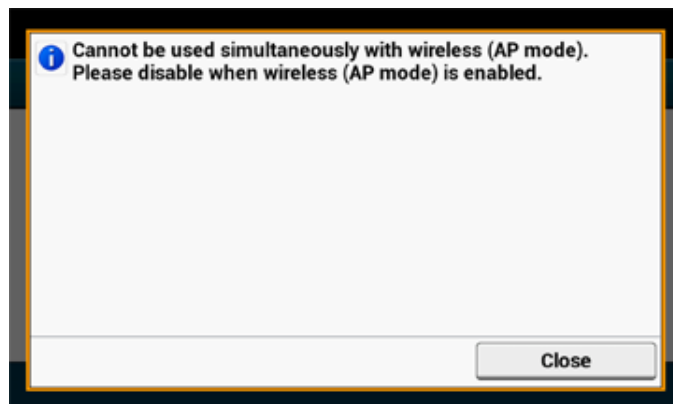

7 Press [Enable].

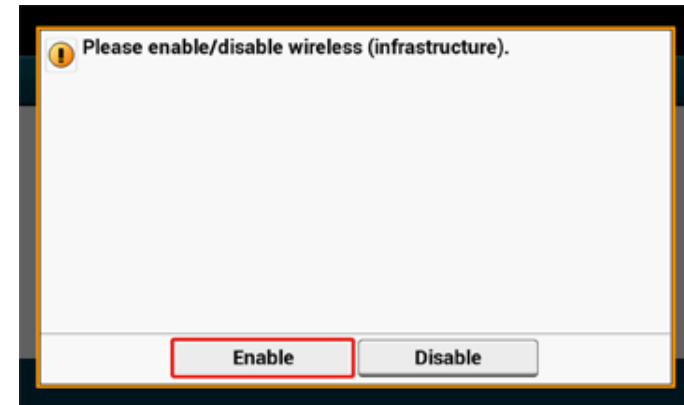

8 If your environment requires to set IP address, etc. manually, press [Network Setting]. If you do not need to set manually, go to step 12.

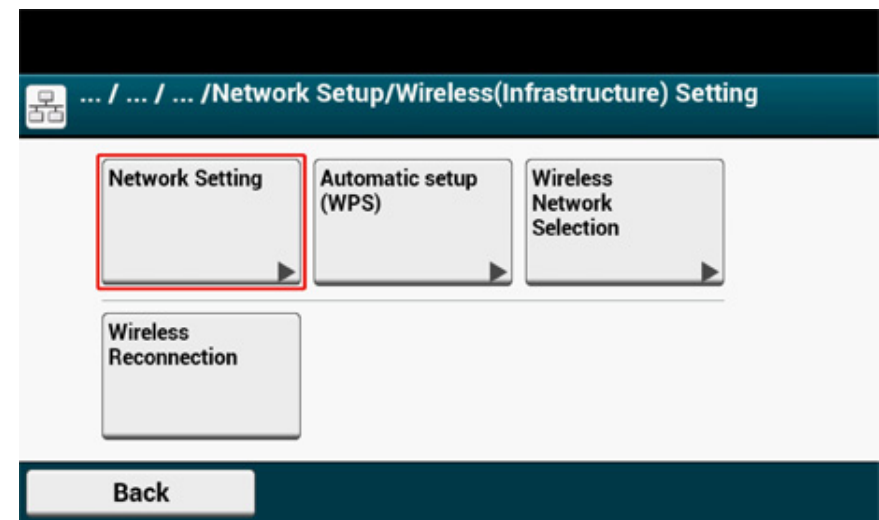

- 9 Press [Manual] on the [Wireless (infrastructure) settings] screen.

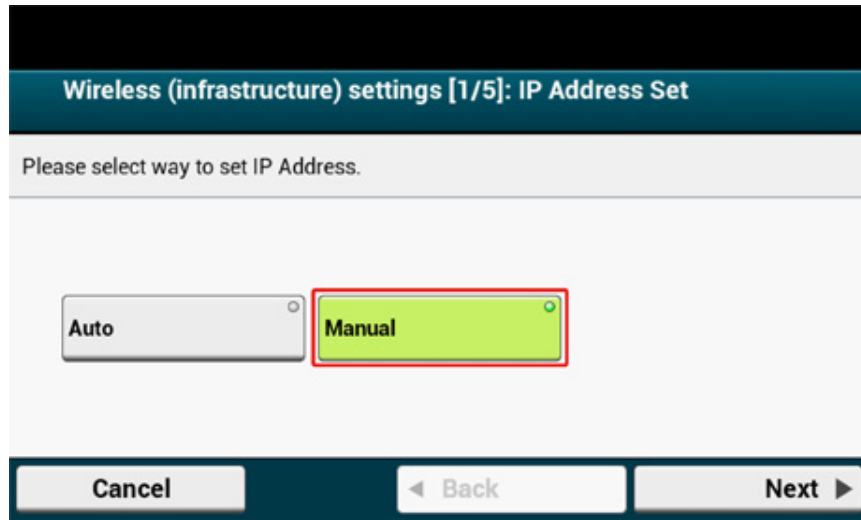

- 10 Follow the onscreen instructions to set the IP address, subnet mask, default gateway, and DHCP v6.



Ask your provider or network administrator about the setting value.

- 11 Press [Close] when the Wireless (infrastructure) settings are complete.



The screen switches automatically in a while without pressing [Close].

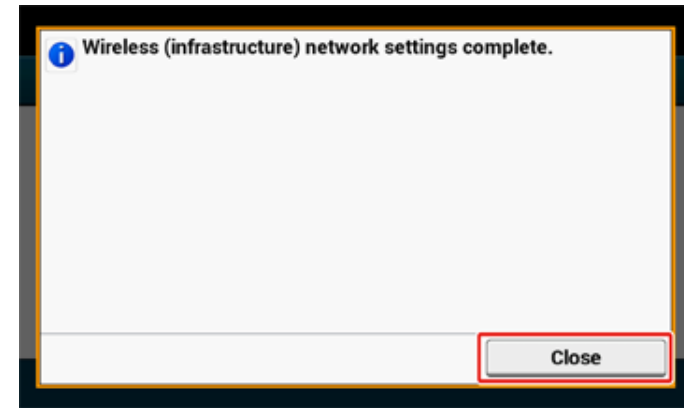

- 12 Press [Wireless Network Selection].

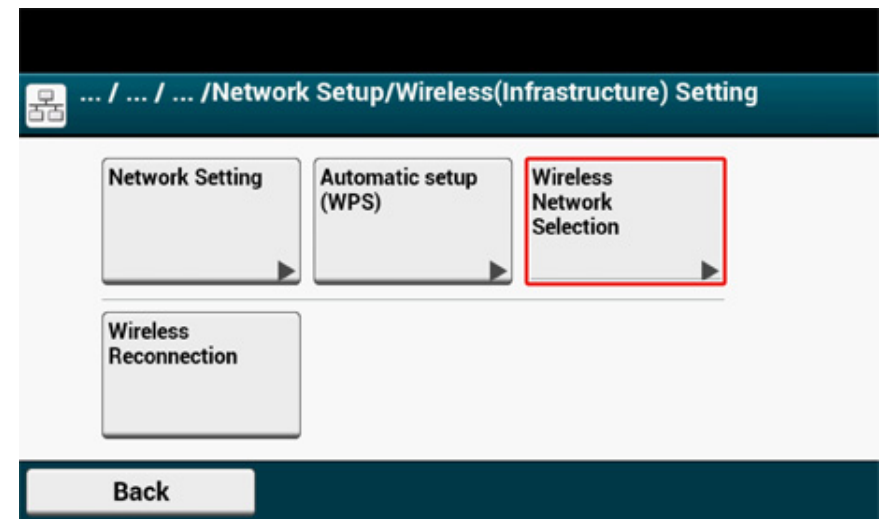

The machine starts searching for wireless LAN access points. Wait for a while.

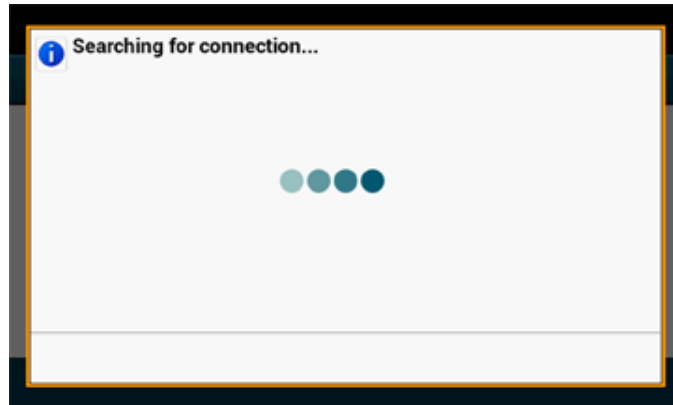

13 Press [Manual Setup].



14 Enter the SSID that you checked in step 1, and then press [Next].



The SSID is case sensitive. Enter the SSID correctly.

15 Select the encryption method that you checked in step 1, and then press [Next].

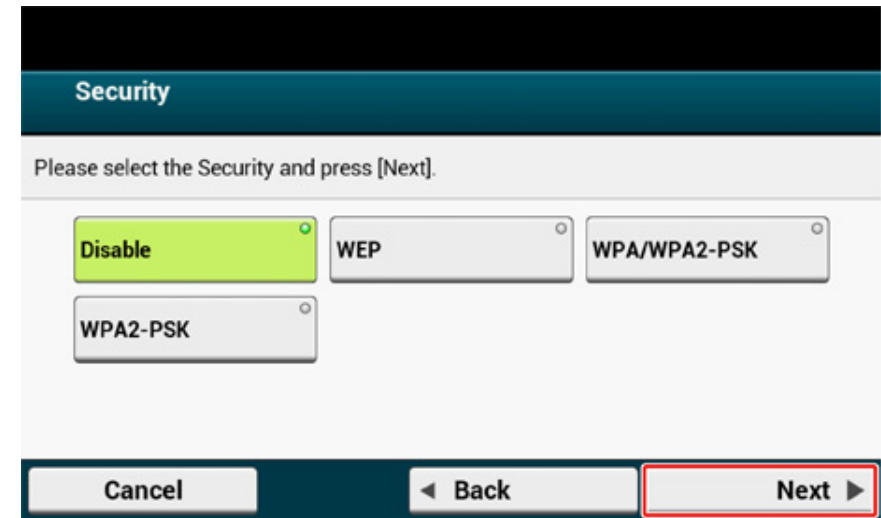

The encryption key varies depending on the wireless LAN access point or security.

16 The procedure depends on the encryption method you selected in step 15.
 If you selected [WPA/WPA2-PSK], select [TKIP/AES], and then press [Next]. Enter the Pre-shared Key afterward and select [Next].
 If you selected [WPA2-PSK], select [AES], and then press [Next]. Enter the Pre-shared Key afterward and select [Next].
 If you selected [WEP], enter the WEP Key, and press [Next].

- 17 If the displayed content is the same as that you checked in step 1, press [Yes].

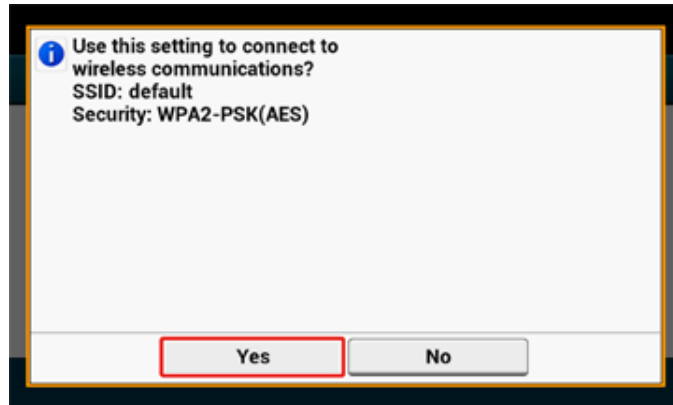

It takes approximately 30 seconds for the machine to detect the wireless LAN access point.

When the screen indicates that connection is established, press [Close].

If the screen indicates that connection failed, press [Close] and go back to step 5.

- 18 If the antenna mark is displayed at the top right of the touch panel, the connection is established correctly.

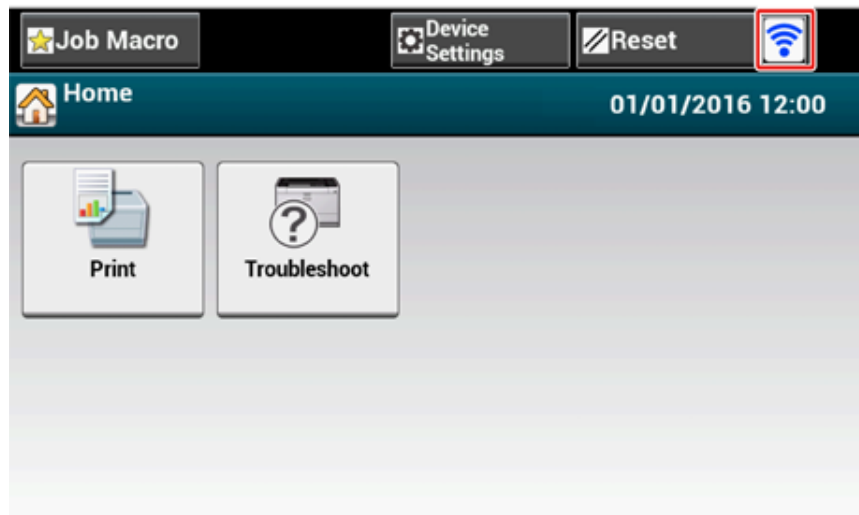

The antenna mark may not be displayed on some screens.

- **If the wireless LAN connection is unstable**

If the wireless LAN connection is unstable, read the cautions in "Before Connecting to a Wireless LAN", and then change the positions of the machine and wireless LAN access point. If you cannot find a solution even after reading the cautions, bring the machine and the wireless LAN access point close to each other.

Connecting to the Machine Directly

Wireless LAN (AP mode) directly connects wireless devices (computers, tablets, smartphones, etc.) to the machine without using a wireless LAN access point.



- If there is metal, aluminum sash, or a reinforced concrete wall between the machine and wireless devices, connections may be harder to be established.
- Up to four devices can be connected to the machine via the wireless LAN (AP mode). The fifth device will be rejected.

• Automatic connection (push-button)

If your wireless devices support WPS-PBC (push button), you can connect to the wireless LAN (AP mode) with the WPS button.

• Manual Setup

If your wireless devices do not support WPS-PBC (push button), you can enter [SSID] and [Password] of the machine in your wireless devices to connect to the wireless LAN (AP mode).

Automatic connection (push-button)

If your wireless devices support WPS-PBC (push button), you can connect to the wireless LAN (AP mode) with the WPS button.

1 Confirm the position of the WPS button on your wireless device by the manual attached to the device.

2 Turn the machine on.



If the [Do you want to Set-up wireless?] message appears, select the [Do not show next time.] check box, and then press [No].

3 Press [Device Settings] on the touch panel.

4 Press [Admin Setup].

5 Enter the administrator name and password and press [OK].

The factory default administrator name and password are "admin" and "999999" respectively.

6 Press [Network Menu].

7 Press [Network Setup].

8 Press [Wireless(AP Mode) Setting].

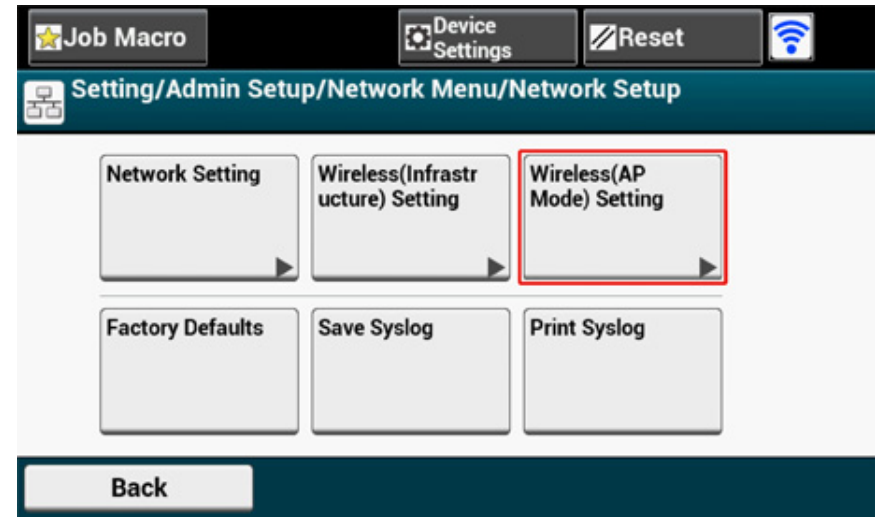

The message below is displayed for about five seconds.

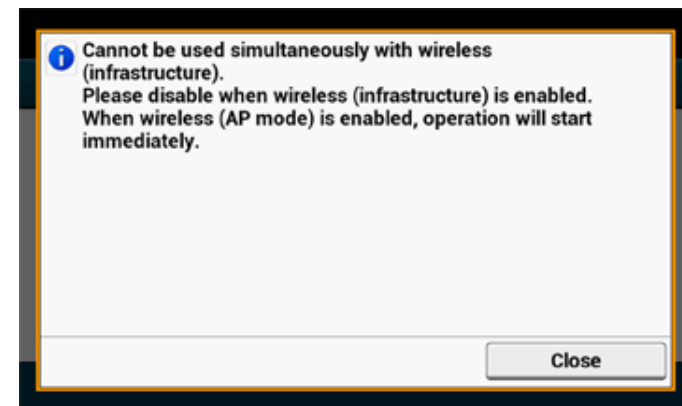

9 Press [Enable].

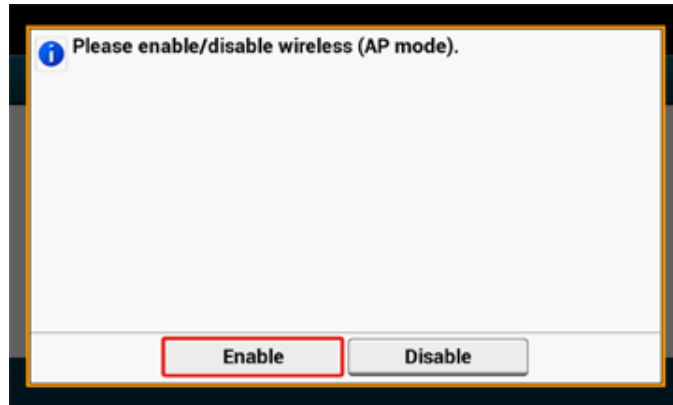

10 Press [Automatic connection (push-button)].

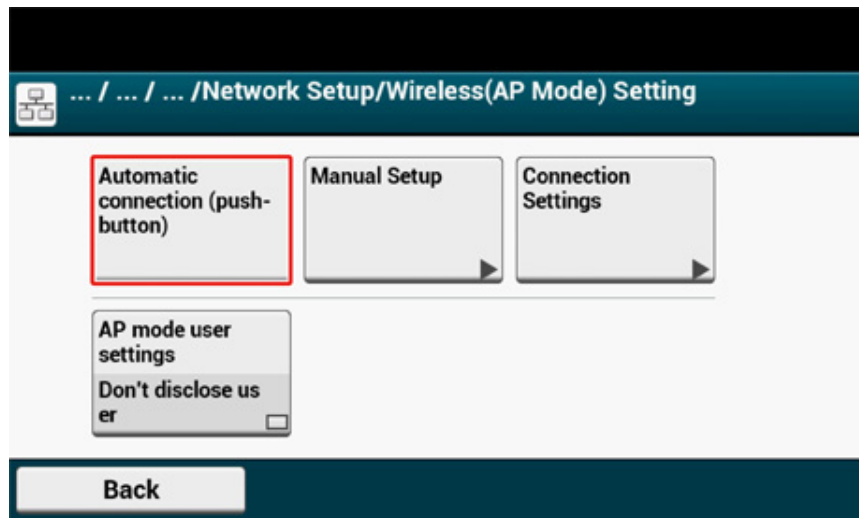

11 Press [Yes].

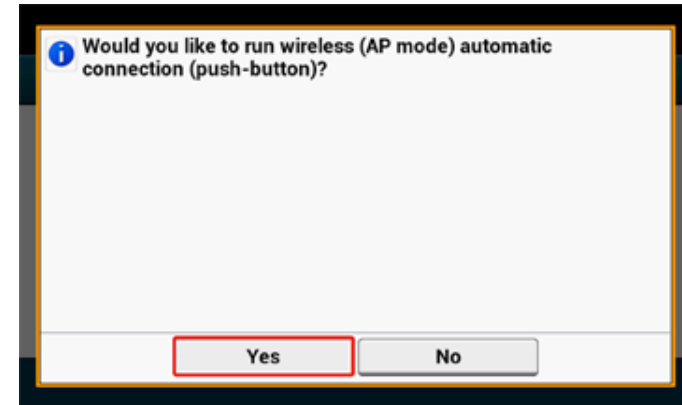

12 Start the WPS-PBC (push button) operation on your wireless device to connect to the machine.

When the following screen appears, the setup of the wireless LAN is completed.

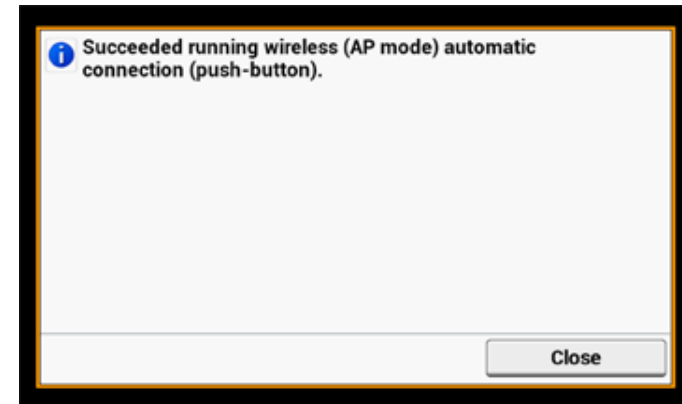

In case of connection failure, follow the steps in "Manual Setup" to try again.

Manual Setup

If your wireless devices do not support WPS-PBC (push button), you can enter [SSID] and [Password] of the machine in your wireless devices to connect to the wireless LAN.

1 Turn the machine on.



If the [Do you want to Set-up wireless?] message appears, select the [Do not show next time.] check box, and then press [No].

2 Press [Device Settings] on the touch panel.

3 Press [Admin Setup] on the touch panel.

4 Enter the administrator name and password and press [OK].

The factory default administrator name and password are "admin" and "999999" respectively.

5 Press [Network Menu].

6 Press [Network Setup].

7 Press [Wireless(AP Mode) Setting].

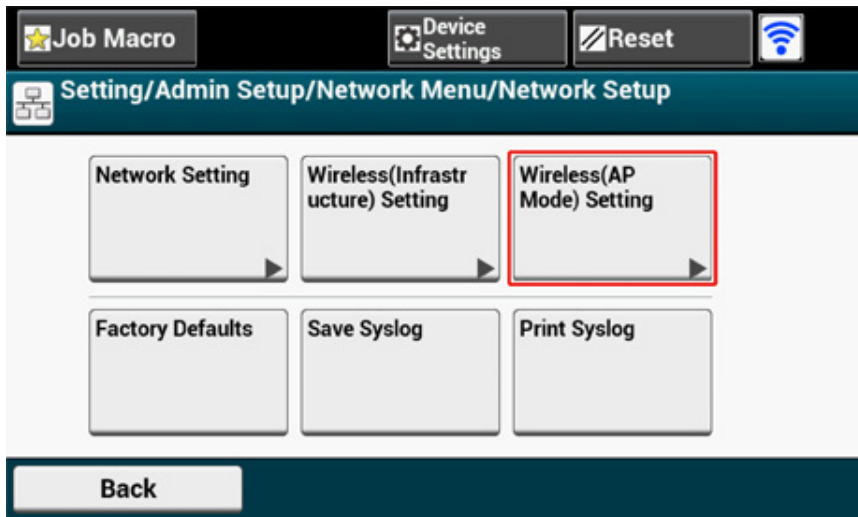

The message below is displayed for about five seconds.

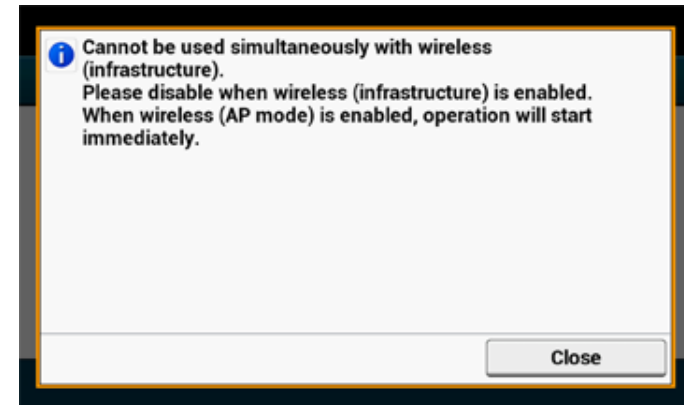

8 Press [Enable].

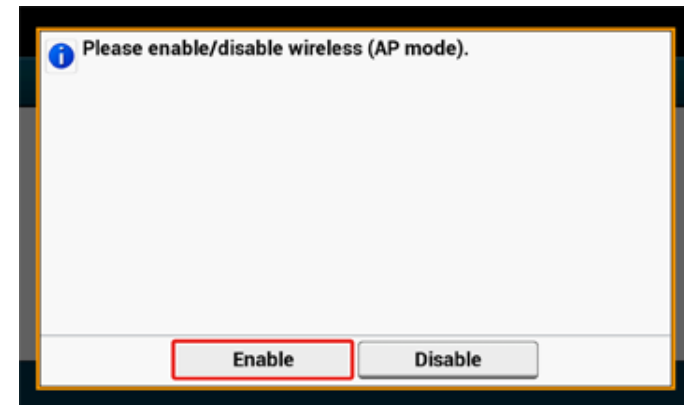

9 Press [Manual Setup].

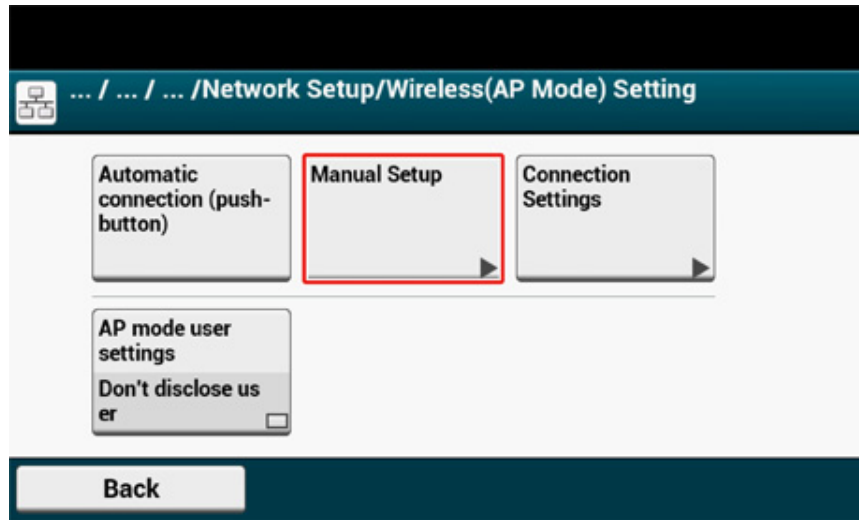

10 Check the [SSID] and [Password] of the machine.

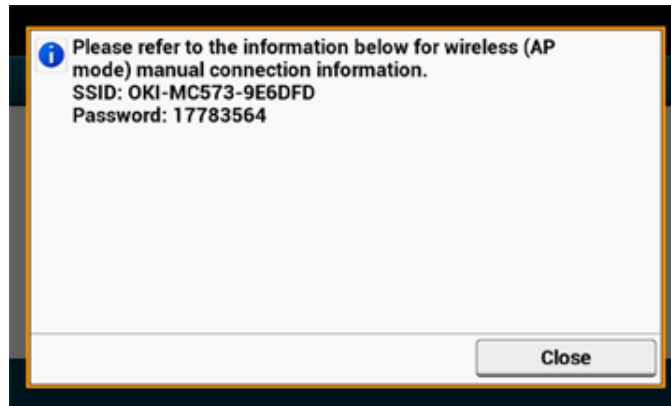

11 Enter the [SSID] and [Password] that you checked in step 10 to connect the machine and your wireless device.

Installing a Driver and Software to a Computer

Install the printer driver from the "Software DVD-ROM" to the computer.

Other utility software can be installed at the same time.

- For Windows
- For Mac OS X

For Windows

Connect the machine and computer via a network or USB cable and start installing.



Check the status of this machine before installing.

- This machine is turned on.
- For network connection, this machine is connected to the network via a LAN cable and required information such as IP address is already set.

- 1 Insert the included "Software DVD-ROM" into a computer.
- 2 When [Auto Play] is displayed, click [Run setup.exe].

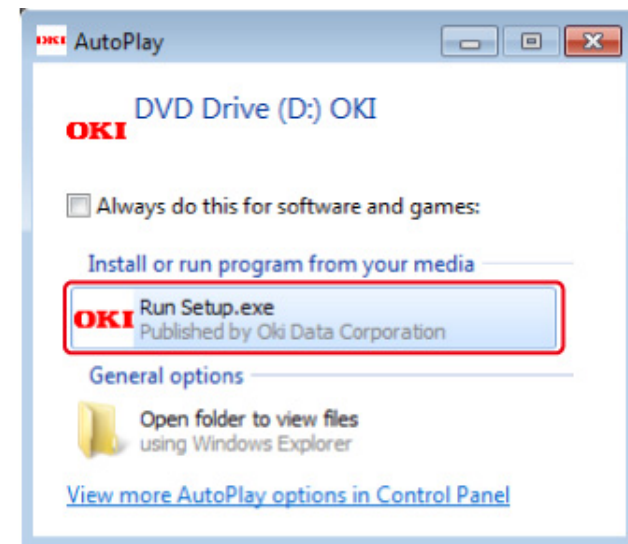

If the [User Account Control] dialog box is displayed, click [Yes].

- 3 Select a language from the drop-down list.
- 4 Read the license agreement, and then click [Accept].
- 5 Read [Environment advice], and then click [Next].

- 6 Select [Network] or [USB connection] in accordance to the connection method of the machine and computer, and then click [Next].

If the [Windows Security Alert] dialog box is displayed, click [Allow access].

- 7 Select the model name of the machine, and then click [Next].

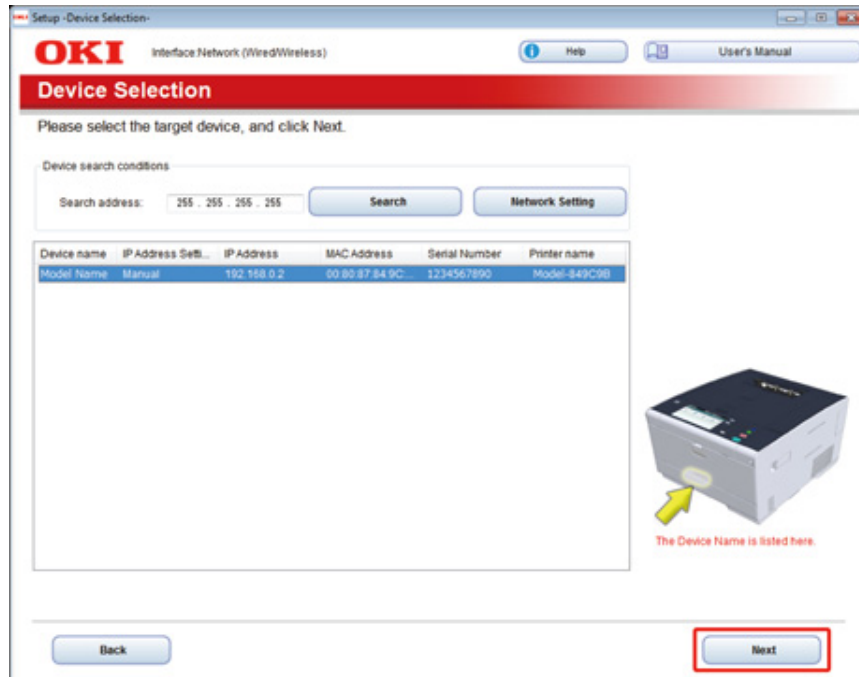

- 8 Click [Install Optional Software].

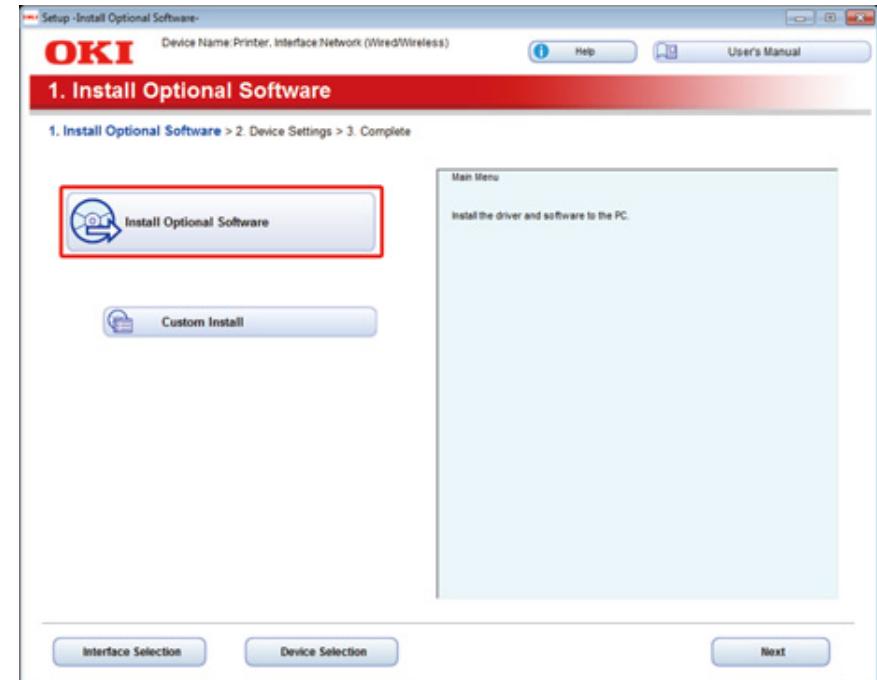

Installation starts.



The following software is installed.

- PCL6 Printer Driver (Including Network Extension and Color Swatch Utility)
- FAQ

Install other software from Custom Install.

- 9 Make sure that the software is successfully installed, and then click [Printing Test].

Select the printer for test printing, and then click [Printing Test].

Make sure that the test printing was successful, and then click [OK].

10 Click [Complete].

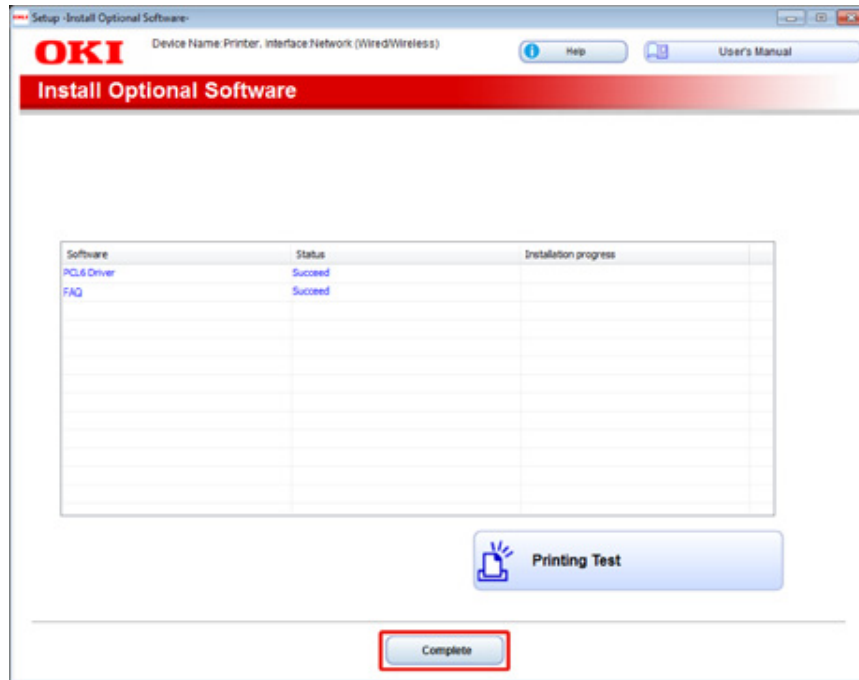

11 Click [Next].

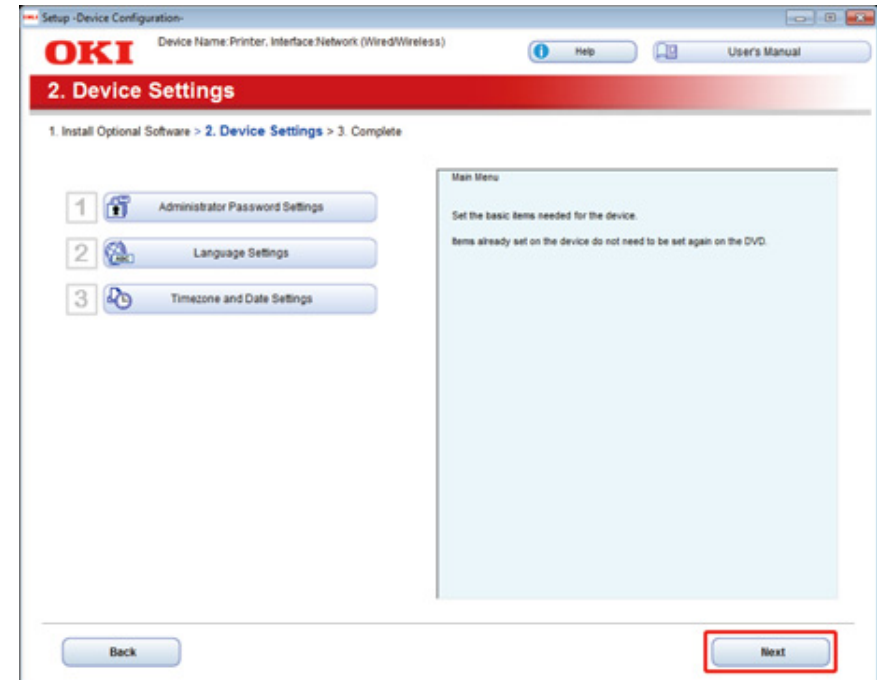

If the following dialog box is displayed, click [Yes].

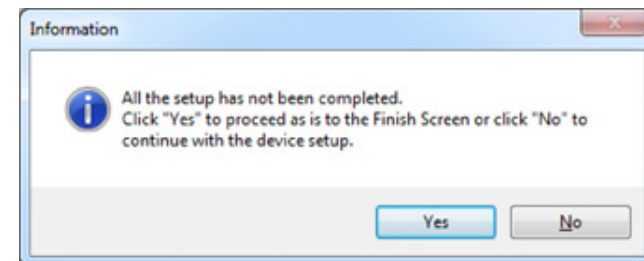

12 Click [Exit].

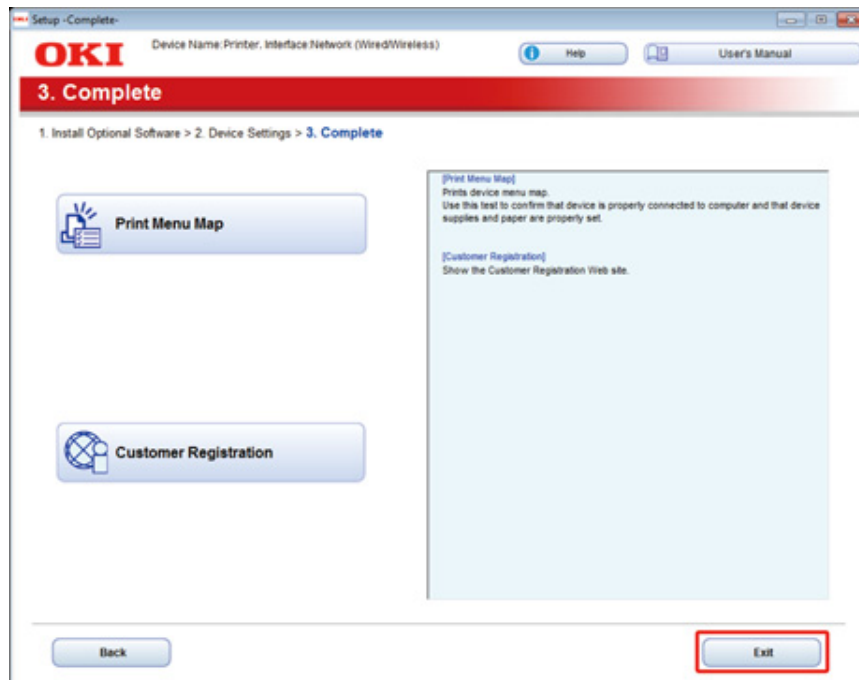

For Mac OS X

This section describes how to install the PS printer driver.

For installation of utilities, see the following.

 [Installing Software \(Advanced Manual\)](#)

- **Install the Mac OS X PS printer driver.**

When the installation is complete, print a test page in step 15.

- 1 Make sure that the machine and a computer are connected and the machine is turned on.
- 2 Insert the "Software DVD-ROM" into a computer.
- 3 Double-click the [OKI] icon on the desktop.
- 4 [Drivers] > [PS] > Double-click [Installer for OSX].
- 5 Enter the administrator password, and then click [OK].
Follow the on-screen instructions to complete the installation.
- 6 Select [System Preferences] from the Apple menu.
- 7 Click [Printers & Scanners].

- 8 Click [+].
Select [Add Printer or Scanner...] when the menu is displayed.

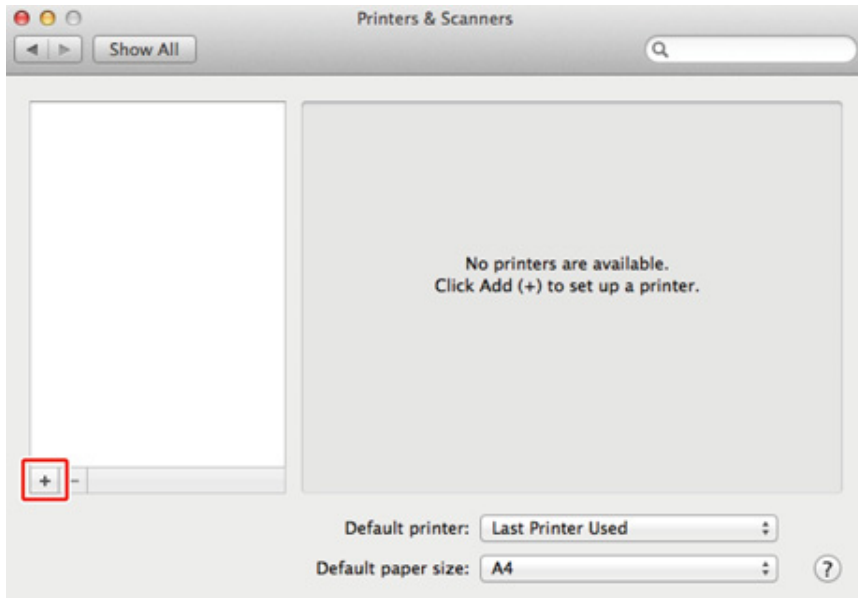

- 9 Click [Default].
- 10 Select the machine , and then make sure that [OKI C542 PS] is displayed for [Use].

Types of Names	Displayed in the Connection	Methods List
Network	OKI-C542 (last 6 digits of MAC address)	Bonjour
USB	OKI DATA CORP C542	USB



To change the name, enter a new name into [Name:].

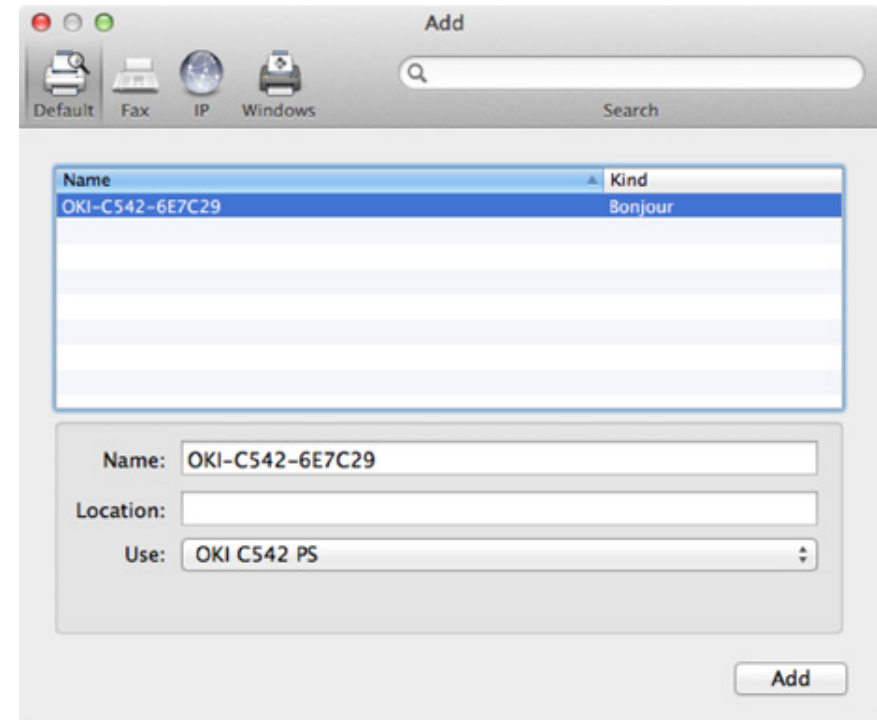

- 11 Click [Add].
- 12 If [Installable options] is displayed, click [Continue].

- 13 Make sure that the machine is added to [Printers] and [OKI C542 PS] is displayed for [Kind].

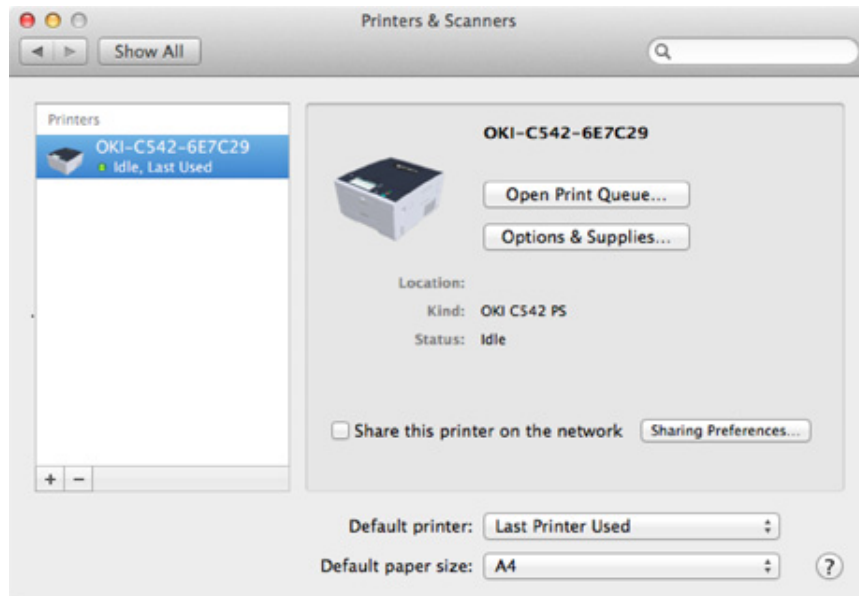

If [OKI C542 PS] is not displayed for [Kind] correctly, click [-], delete the machine from [Printers], and then newly perform steps 8 to 12.

- 14 Click [Open Print Queue...].
- 15 Select [Print Test Page] from the [Printer] menu.

3

Basic Operations

Names of Components

Basic Operations on the Operator Panel

Turning the Machine On or Off

Loading Paper

This section describes basic operations of this machine.

Names of Components

The chapter describes the name of each component.

- Front View
- Rear View
- Inside of the machine

Front View

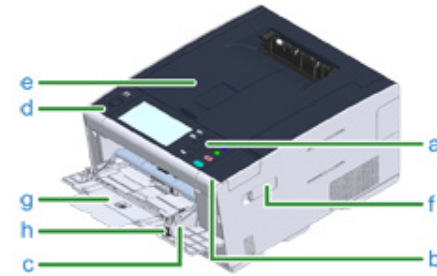

Symbol	Name
a	Operator panel  Basic Operations on the Operator Panel
b	USB port
c	MP tray (Multipurpose tray)
d	Open button
e	Output tray (Top cover)
f	Wireless LAN module cover
g	Paper supporter
h	Envelope lever (Use this when printing on envelopes. For instructions, refer to the Advanced Manual.)

Rear View

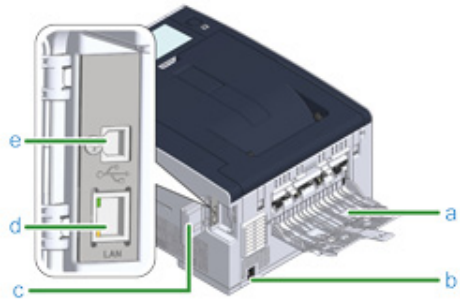

Symbol	Name
a	Rear output tray
b	Power connector
c	Interface connector cover
d	Network interface connector
e	USB interface connector

Inside of the machine

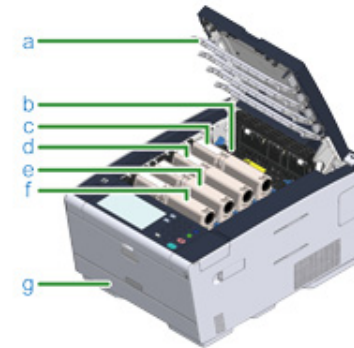

Symbol	Name
a	LED head
b	Fuser unit
c	Toner cartridge / Image drum (Y: yellow)
d	Toner cartridge / Image drum (M: magenta)
e	Toner cartridge / Image drum (C: cyan)
f	Toner cartridge / Image drum (K: black)
g	Tray 1

Basic Operations on the Operator Panel

This section describes the operator panel of the machine.

- Names and Functions
- Name and Functions on the Touch Panel
- Adjusting the Angle of the Operator Panel
- Entering Characters

Names and Functions

This section describes the names and functions of components on the operator panel.

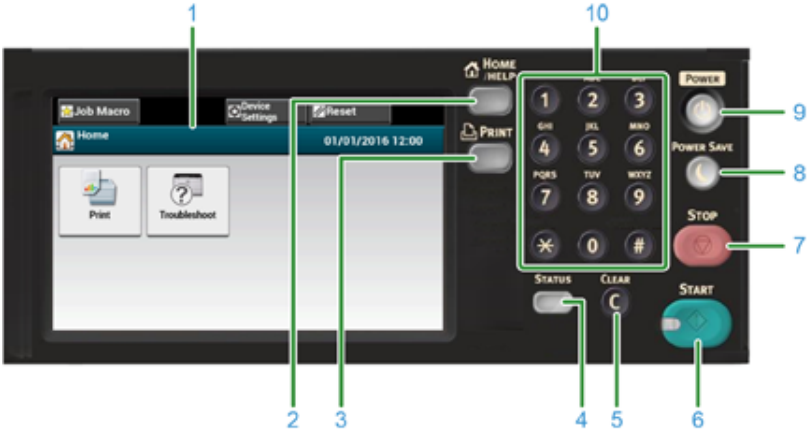

No.	Name	Function
1	Touch panel	Allows you to select or set an item by pressing a displayed icon.
2	HOME/HELP button	Displays the home screen.
3	PRINT button	Displays the print function screen.
4	STATUS button	Displays the status menu. Flashes/lights up if there is an error status. You can check the remaining amount of consumables.
5	CLEAR button	Clear the entered value.
6	START button	Starts printing from USB Memory.
7	STOP button	Cancels printing.
8	POWER SAVE button	Enters or exits the power saving mode. In Power Save mode, lights up in green; In Sleep mode, flashes in green (every 3 seconds); In Deep Sleep mode, flashes in green (every 6 seconds).
9	POWER button	Turns this machine on or off.
10	Numeric keypad	Enters numbers and symbols.



- When changing the angle of the operator panel, use care not to let your hands be caught between this machine and the operator panel. Injury may result.
- Do not press the touch panel hard or poke it with a pointed object. It may damage the touch panel and cause malfunction.

Name and Functions on the Touch Panel

When this machine turns on, the home screen is displayed on the touch panel.

• **Home Screen**

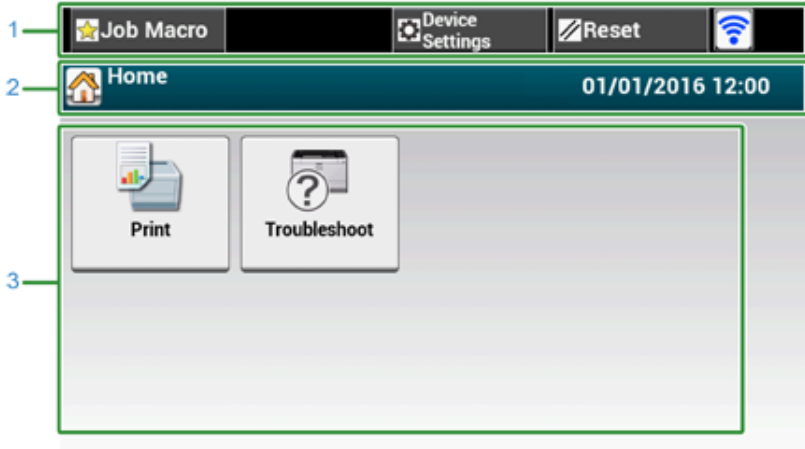

The screen image shows the factory default setting. The screen that appears when the machine is turned on and gets ready to be used can be changed from [Device Settings] > [Admin Setup] > [Manage Unit] > [Default Mode] on the touch panel.

	Item	Description
1	Stationary button area	Displays buttons that appear on the screen at all times. Displays the following items. <ul style="list-style-type: none"> • [Job Macro] • [Function Settings] • [Device Settings] • [RESET] • [Logout] • Antenna mark: appears when the wireless LAN is enabled. • [?] Only available buttons are displayed on the selected menu.
2	Title and operation guide area	Displays the title of the current screen and provides guide for possible operations.

	Item	Description
3	Main area	Press to use the print functions. The following steps and functions are displayed. <ul style="list-style-type: none"> • Change Consumable & Maintain (Toner cartridges, Image drums, Belt units, Fuser units) • Maintain and Care for the Unit (Feeder Rollers, LED head)

• **Name and Function of the Device Settings Screen**

[Basic] tab > [Paper Setup/MP Tray] screen is used as an example.

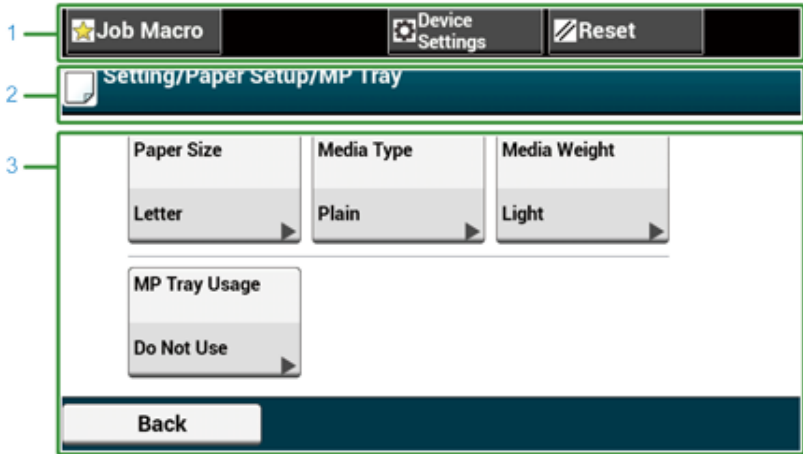

	Item	Description
1	Stationary button area	Displays buttons that appear on the screen at all times. Only available buttons are displayed on the selected menu.
2	Title and operation guide area	Displays the title of the current screen and provides guide for possible operations.
3	Main area	The current setting is displayed on each button. <About the mark on a button> ► : Indicates that the next page exists.



You can enter a value in the field with [grid icon] displayed by using the numeric keypad.



About the top screen

 Names and Functions of Screen Items for Print

Adjusting the Angle of the Operator Panel

The operator panel can be tilted to improve the visibility.

- 1 Hold the upper center of the operator pane and pull it forward.



To set the operator panel back to the original position, pull the operator panel forward until it stops and then push slowly.

Entering Characters

- Entering with the Touch Panel
- Entering with the Numeric Keypad

Entering with the Touch Panel

When you need to enter characters while you are setting an item, the following entry screen is displayed.

You can enter uppercase and lowercase alphabets, numbers, and symbols.

- **About the entry screen**

The number of buttons in the entry screen differs depending on the input.

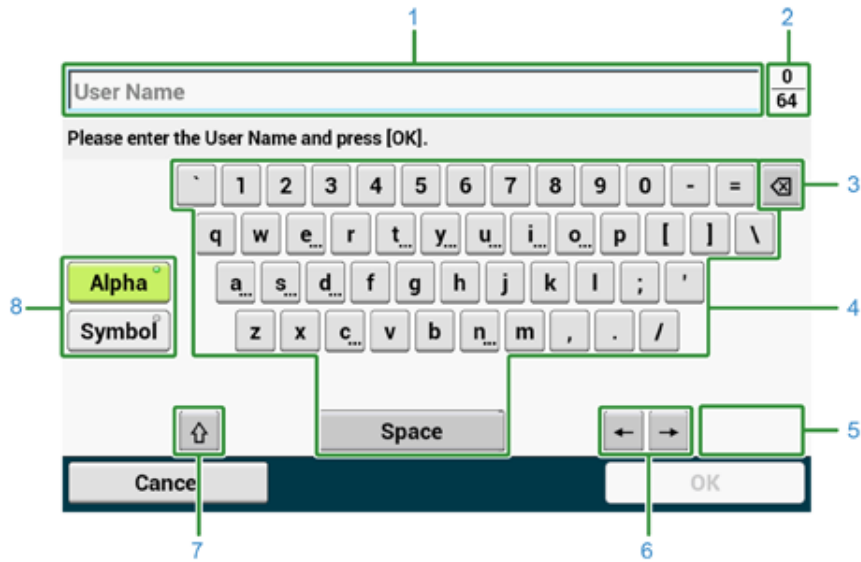

	Item	Description
1	Text entry field	Displays the entered characters.
2	The number of entered characters/the maximum number of characters that can be entered	Indicates the maximum number of characters that can be entered and the number of entered characters.
3	Back Space button	Deletes a character just before the cursor.

	Item	Description
4	Character panel	Enters characters. The character type switches depending on the entry mode.
5	Left button/right button	Moves the cursor left and right.
6	Capital Lock	Switches between the uppercase and lowercase characters.
7	Entry mode button	Switches the entry mode (types of characters) for entering text.



The QWERTY keyboard set by default can be switched to the AZERTY keyboard. To switch to the AZERTY keyboard, select [Manage Unit] > [Keyboard Layout] > [AZERTY] on the touch panel.

- **Entering Characters**

- 1 Press the touch panel.
- 2 When the entry is complete, press [OK] or [Next].



To enter a diacritical mark, press and hold a character button with [...] shown. When a diacritical mark appears, press the character you want to enter.

The screen below shows an image when holding down the "a" button.

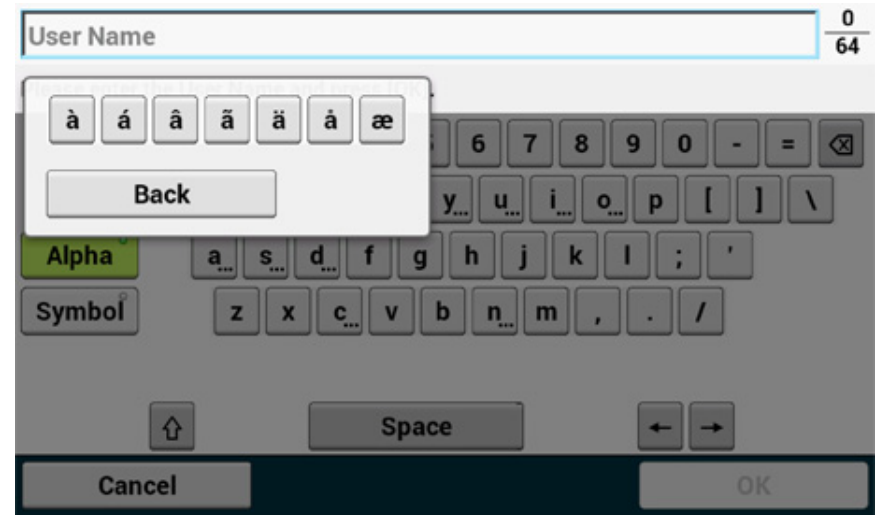

• **Switching the Entry Mode (Numbers ↔ Alphabetic Characters)**

1 Press [Alpha] or [Symbol].



[RU] may be shown in case of Russian, and [EL] in case of Greek. In case of other languages, only [Alpha] and [Symbol] may be shown.

• **Switching the Entry Mode (Uppercase ↔ Lowercase)**

1 Press the button to switch between the uppercase and lowercase characters.

• **Deleting an Entered Character**

1 Use the [Backspace] (back space) button on the touch panel or the [CLEAR] (CLEAR) button on the operator panel.

The character before the cursor (|) is deleted.



To delete an entered character, move the cursor to the right of the character. To move the cursor, press [Left Arrow] or [Right Arrow].

Entering with the Numeric Keypad

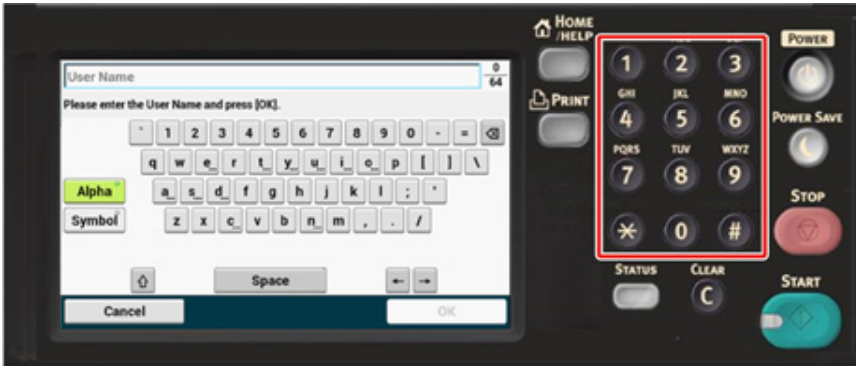

You can enter the numbers labeled on each key.



It is impossible to enter the alphabet.

Please enter the alphabet from the touch panel.

• **Deleting an Entered Character**

To delete the character to the left of the cursor, press the [CLEAR] (CLEAR) button.

To clear characters you entered in a row, press and hold the [CLEAR] (CLEAR) button.



Turning the Machine On or Off

This section describes how to turn on and off the machine.

- Turning the Machine On
- Turning the Machine Off

Turning the Machine On

1 Press the power switch for approximately a second.



When the machine is turned on, the power switch LED lamp lights up.



2 The home screen appears when the machine is ready.

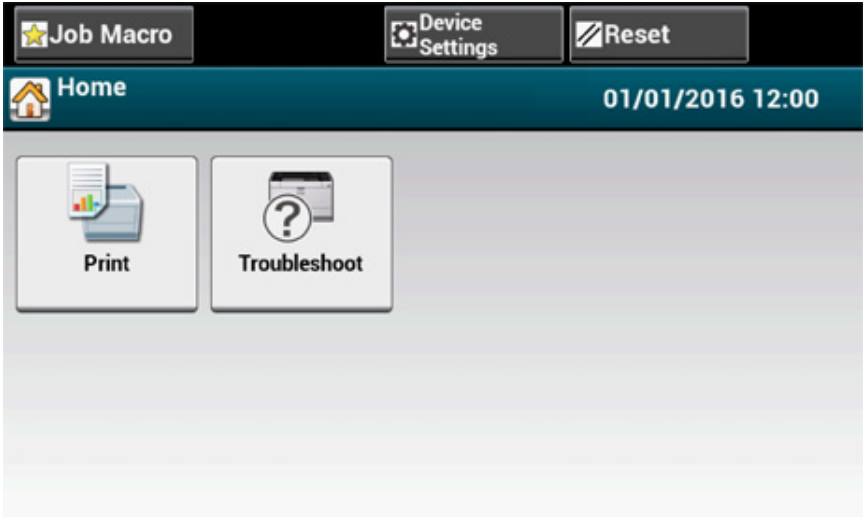

Turning the Machine Off



- Check that the machine is not receiving data before shutting down.
- Press and hold the power switch for 5 seconds or more to force shut down the machine. Use this method only if a problem occurs.

For troubleshooting of this machine, see "Troubleshooting".

1 Press the power switch for approximately a second.



The "System moves to shutdown. Please confirm status when status LED is blinking." message is displayed on the touch panel, and the power switch LED lamp flashes at approximately one-second intervals.

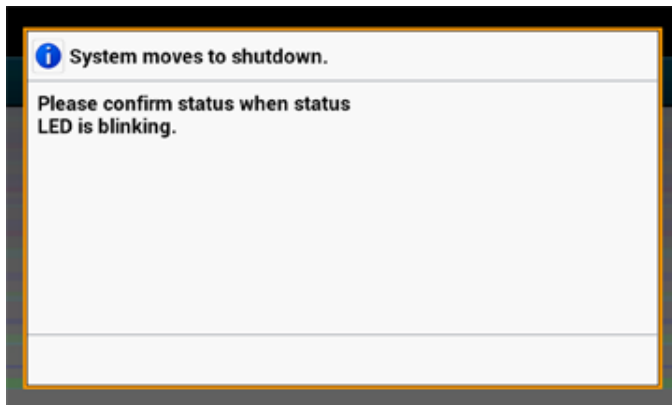

After a while, the machine automatically turns off, and the power switch LED lamp goes out.



What You Should Do If You Do Not Use This Machine for an Extended Period of Time

If you do not use this machine for an extended period of time due to holidays, trips, or other reasons, unplug the power cord from the outlet.



This machine does not have functional failures if the power cord is unplugged for an extended period of time (four weeks or more).

Loading Paper

This chapter describes various information about paper that can be loaded in a paper tray of this machine.

To set paper type and weight, press [Device Settings] > [Paper Setup] and press the tray you want to use, and then select [Media Type] or [Media Weight].

-
- About Paper Types That Can be Loaded
 - Loading Paper in Tray 1/2/3
 - Loading Paper in the MP Tray
 - Paper Storage
-

About Paper Types That Can be Loaded

- Available paper types
- About Paper Sizes, Weight, and Number of Sheets That Can be Loaded
- Recommended paper

Available paper types

To perform high-quality printing, be sure to use the supported paper types that satisfy requirements, such as material, weight, or paper surface finishing. Use digital photo print paper.

If you print on paper that is not recommended by Oki Data, check the print quality and the movement of the paper thoroughly in advance to ensure that there are no problems.

• Paper type

Paper size (mm) (The value enclosed with brackets is indicated in inches.)		Paper weight
A4	210 x 297	64 to 220 g/m ² (17 to 58 lb)
A5	148 x 210	For duplex printing, 64 to 176 g/m ² (17 to 47 lb)
A6	105 x 148	
B5	182 x 257	 If you set paper that is 148 mm (5.8 inches) wide or narrower, printing becomes slower.
B6	128 x 182	
B6 Half	64 x 182	
Letter	215.9 x 279.4 (8.5 x 11)	
Legal 13	215.9 x 330.2 (8.5 x 13)	
Legal 13.5	215.9 x 342.9 (8.5 x 13.5)	
Legal 14	215.9 x 355.6 (8.5 x 14)	
Executive	184.2 x 266.7 (7.25 x 10.5)	
Statement	(5.5 x 8.5)	
8.5" SQ	(8.5 x 8.5)	
Folio (210 x 330 mm)	210 x 330	
16K (184 x 260 mm)	184 x 260	
16K (195 x 270 mm)	195 x 270	
16K (197 x 273 mm)	197 x 273	
Index Card	(3 x 5)	
4x6inch	(4 x 6)	
5x7inch	(5 x 7)	
Custom size	Width: 64 to 216 Length: 90 to 1321	

• Envelope

Paper size (mm) (The value enclosed with brackets is indicated in inches.)		Paper weight
Monarch	98.4 x 190.5 (3.875 x 7.5)	Envelopes must be made of paper of 85 g/m ² (24 lb), and their flaps must be folded.
Com-9	98.4 x 225.4 (3.875 x 8.875)	
Com-10	104.8 x 241.3 (4.125 x 9.5)	
DL	110 x 220 (4.33 x 8.66)	
C5	162 x 229 (6.4 x 9)	

• Label

Paper size (mm) (The value enclosed with brackets is indicated in inches.)		Paper weight
A4	210 x 297	0.1 to 0.2 mm
Letter	8.5 x 11 (215.9 x 279.4)	

• Other type of paper

Paper type	Paper size	Paper weight
Partly-printing paper	Subject to plain paper	64 to 220 g/m ² (17 to 58 lb)
Color paper	Subject to plain paper	64 to 220 g/m ² (17 to 58 lb)

About Paper Sizes, Weight, and Number of Sheets That Can be Loaded

Available paper sizes and types, and tray capacity are as follows.

• Tray 1

Available paper size	Tray capacity	Paper weight
A4	250 sheets (if paper weight is 80 g/m ²)	Light
A5		(64 to 74 g/m ²)
A6*1		Medium Light
B5		(75 to 82 g/m ²)
B6*1		Medium
Letter		(83 to 90 g/m ²)
Legal (13 inches)		Medium Heavy
Legal (13.5 inches)		(91 to 104 g/m ²)
Legal (14 inches)		Heavy
Executive		(105 to 120 g/m ²)
Statement*1		Ultra Heavy1
8.5" SQ (8.5 x 8.5 inches)		(121 to 176 g/m ²)
Folio (210 x 330 mm)		
16K (184 x 260 mm)		
16K (195 x 270 mm)		
16K (197 x 273 mm)		
Custom size*2		

*1 Paper cannot be used for duplex printing.

*2 Width: 100 to 216 mm (3.9 to 8.5 inches), Length: 148 to 356 mm (5.8 to 14 inches)

• **Tray 2/3 (Optional)**

Available paper size	Tray capacity	Paper weight
A4	530 sheets (if paper weight is 80 g/m ²)	Light
A5		(64 to 74 g/m ²)
B5		Medium Light
Letter		(75 to 82 g/m ²)
Legal (13 inches)		Medium
Legal (13.5 inches)		(83 to 90 g/m ²)
Legal (14 inches)		Medium Heavy
Executive		(91 to 104 g/m ²)
8.5 SQ (8.5 x 8.5 inches)		Heavy
Folio (210 x 330 mm)		(105 to 120 g/m ²)
16K (184 x 260 mm)		Ultra Heavy 1
16K (195 x 270 mm)		(121 to 176 g/m ²)
16K (197 x 273 mm)		
Custom size*1		

*1 Width: 148 to 216 mm (5.8 to 8.5 inches), Length: 210 to 356 mm (8.3 to 14 inches)

• **MP Tray**

Available paper size	Tray capacity	Paper weight
A4	100 sheets	Light
A5		(64 to 74 g/m ²)
A6*1		Medium Light
B5		(75 to 82 g/m ²)
B6*1		Medium
B6 Half*1		(83 to 90 g/m ²)
Letter		Medium Heavy
Legal (13 inches)		(91 to 104 g/m ²)
Legal (13.5 inches)		Heavy
Legal (14 inches)		(105 to 120 g/m ²)
Executive		Ultra Heavy1
Statement*1		(121 to 176 g/m ²)
8.5 SQ (8.5 x 8.5 inches)		Ultra Heavy2
Folio (210 x 330 mm)		(177 to 220 g/m ²)
16K (184 x 260 mm)		
16K (195 x 270 mm)		
16K (197 x 273 mm)		
Index card (3x5 inches)*1		
4x6inch*1		
5x7inch*1		
Custom size*2		
Com-9*1		
Com-10*1		
Monarch*1		
DL*1		
C5*1		

*1 Paper cannot be used for duplex printing.

*2 Width: 64 to 216 mm (2.5 to 8.5 inches), Length: 90 to 1,321 mm (3.5 to 52 inches)

Recommended paper

The machine supports a variety of print media, including a range of paper weights and sizes. This section describes how to choose and use media. To obtain the best performance, use 75 to 90 g/m² plain paper that is designed for use in copiers and laser printers. Use of heavily embossed or very rough textured paper is not recommended. Pre-printed stationery can be used, but the ink must not offset when exposed to the high fuser temperatures used in the printing process.

• **Envelopes**

Envelopes must be free from twists, curls or other deformations. The envelopes must also be of the rectangular flap type, with glue that remains intact when subjected to hot roll pressure fusing in the machine. Window envelopes are not suitable.

• **Labels**

Labels must be of the type recommended for use in copiers and laser printers, in which the base carrier page is entirely covered by labels. Other types of label stocks may damage the machine due to the labels peeling off during the printing process.

Loading Paper in Tray 1/2/3

The procedure when loading paper in Tray 1 is used as an example, and the same procedure applies to Tray 2/3 (optional).

- 1 Pull the paper cassette out.



- 2 Slide the paper guide (a) to the width of paper to be loaded.

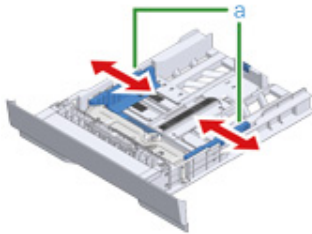

- 3 Slide the paper stopper (b) to the length of paper to be loaded.

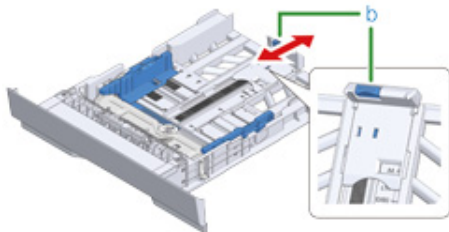

- 4 Fan a stack of paper well, and then align the edges of the paper.

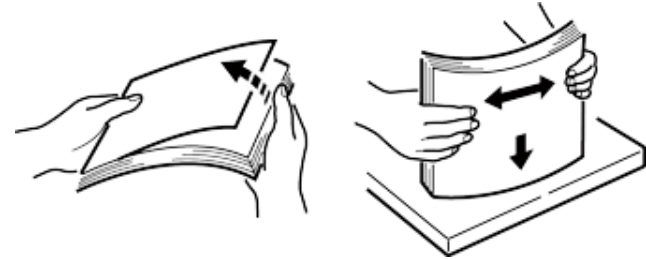

- 5 Load paper with the print side face down.



Do not load paper above the "▽" mark on the paper guide.

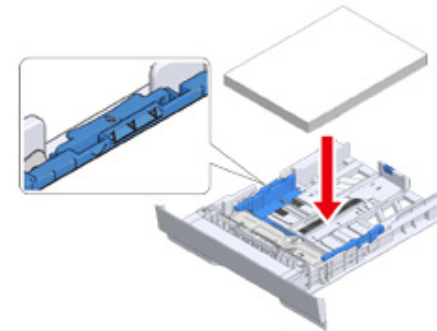

- 6 Secure the loaded paper with the paper guide.

- 7** Push the paper cassette until it stops.



- 8** Press [Device Settings] on the touch panel.
9 Press [Paper Setup].
10 Press the tray in which paper is loaded.
11 Set [Paper Size], [Media Type], and [Media Weight].
12 Press [Back] until the home screen is displayed.

Loading Paper in the MP Tray



- Do not press down the paper or hold the paper to pull while printing on the paper fed from the MP tray. To stop printing, open the output tray.
For instructions on how to remove paper, see "If Paper Jams Occur".
- If you open and close the MP tray vigorously, the paper feed roller of MP tray may fall and get in the way of loading paper. If the paper feed roller of MP tray has fallen, raise the paper feed roller of MP tray before loading paper.

- 1** Open the MP tray forward by inserting your finger into the front recess.



- 2** Pull out the paper support by holding the center part of it.



3 Open the sub support.

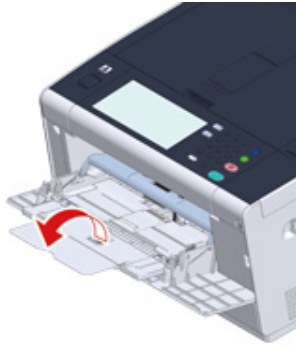

4 Adjust the manual feeding paper guide to the width of paper to be loaded.



5 Make sure that the paper feed roller stays in the proper position.
If the paper feed roller has fallen, push it upward and fix it.

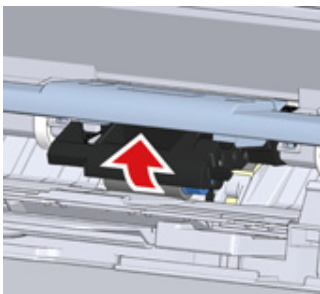

6 Insert the paper with the print side up until its edge touches the paper feed entrance.



Do not load paper above the "▽" mark.

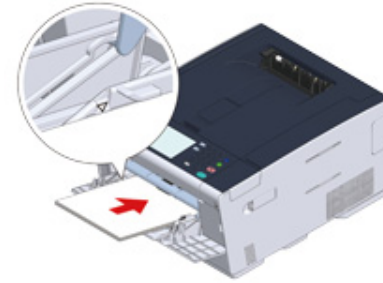

When a printer is in the power saving mode, press the  (Power Save) button to restore from the mode.

7 Set [Paper Size], [Media Type], and [Media Weight] on the paper setup screen.

8 Press [Close].



- Do not load paper in different sizes, types, or weights.
- When adding sheets of paper, remove paper loaded in the MP tray, bundle the whole batch of sheets, and align edges of sheets to load them.
- Do not insert objects other than paper in the MP tray.

Paper Storage

Store paper under the following conditions to maintain quality.

- Inside a cabinet or other dry and dark place
- On a flat surface
- Temperature: 20°C
- Humidity: 50% RH (relative humidity)

Do not store paper in the places as shown below:

- Directly on the floor
- Where paper is exposed to direct sunlight
- Near the inside of an exterior wall
- On an uneven surface
- Where static electricity may be generated
- Where temperature excessively rises high and temperature rapidly changes
- Near this machine, an air conditioner, a heater, or duct



- Do not unwrap paper until just before you use.
- Do not leave paper unwrapped for a long period. Doing so may result in printing problems.
- Depending on the print media, environment, storage conditions, the print quality may deteriorate or printout may get curled.

4

Print

Printing from a Computer (Windows)

Printing from a Computer (Mac OS X)

Cancelling a Print Job

About Screens and Functions of Each Printer Driver

Names and Functions of Screen Items for Print

"WordPad" for Windows and "TextEdit" for Mac OS X are used as examples. The screens and steps may vary depending on the application.

Printing from a Computer (Windows)

- For Windows PCL Printer Driver
- For Windows PS Printer Driver

For Windows PCL Printer Driver

- 1 Open the file to print.
- 2 Select [Print] from the [File] menu.
- 3 Select the printer driver.

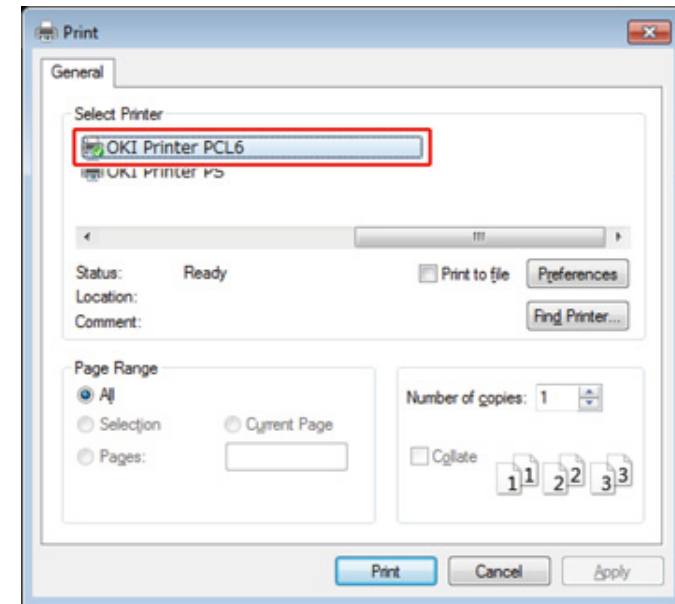

- 4 Click [Preferences].

5 Change the settings in each tab to suit your needs.

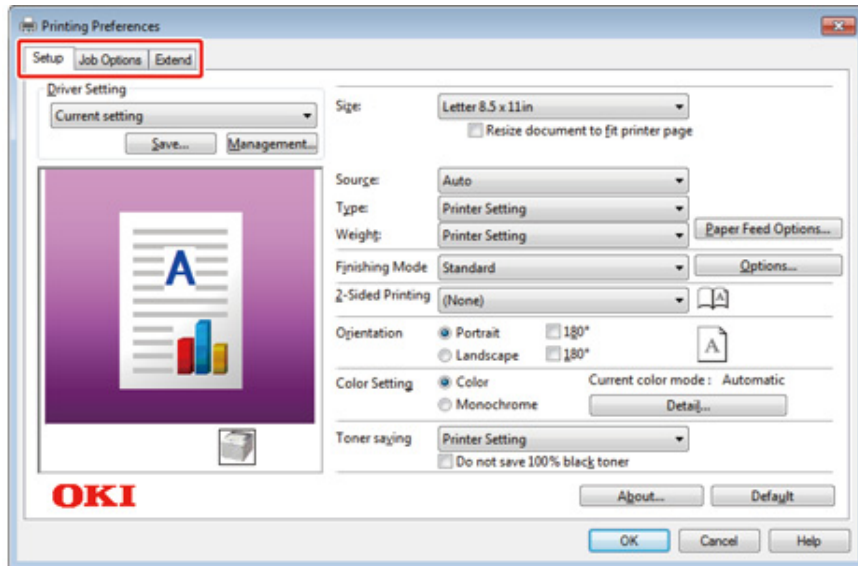

6 Click [OK].

7 Click [Print] on the [Print] Screen.

For Windows PS Printer Driver

1 Open the file to print.

2 Select [Print] from the [File] menu.

3 Select the PS printer driver.

4 Click [Preferences].

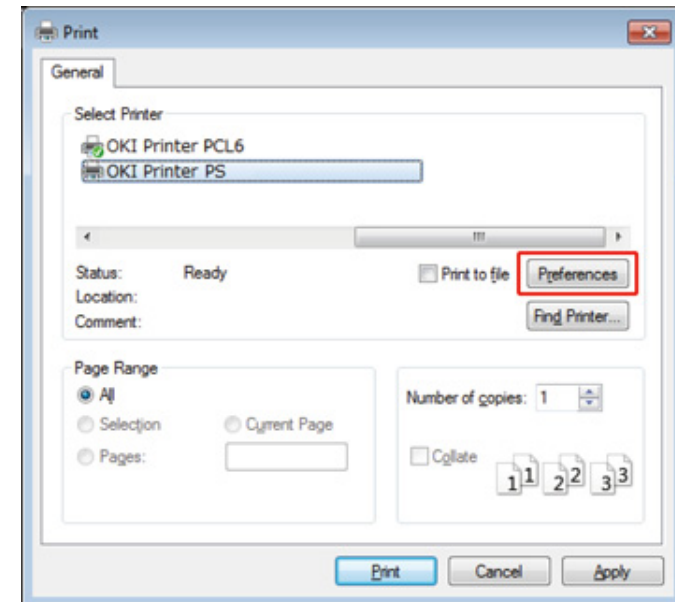

5 Change the settings in each tab to suit your needs.

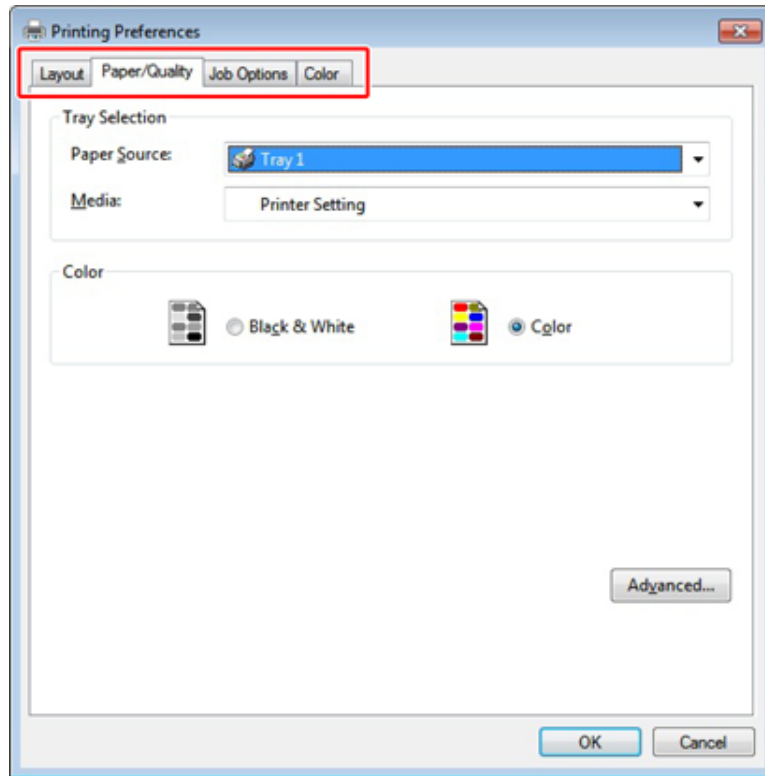

6 Click [OK].

7 Click [Print] on the [Print] screen.

Printing from a Computer (Mac OS X)

- For Mac OS X

For Mac OS X

You can set a paper size, paper tray, and paper weight, and paper type with the printer driver.

- 1 Open the file to print.
- 2 Select [Print] from the [File] menu.

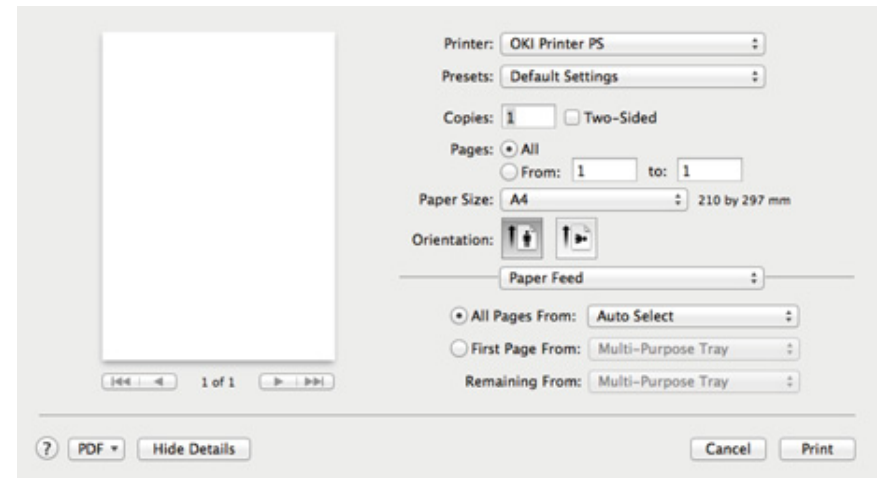

- 3 Select the machine from [Printer].
- 4 Select the paper size from [Paper Size].
- 5 Change the settings on each panel to suit your needs.



If setting details are not displayed in the print dialog box for Mac OS X 10.8.5 to 10.11, click [Show Details] at the bottom of the dialog box.

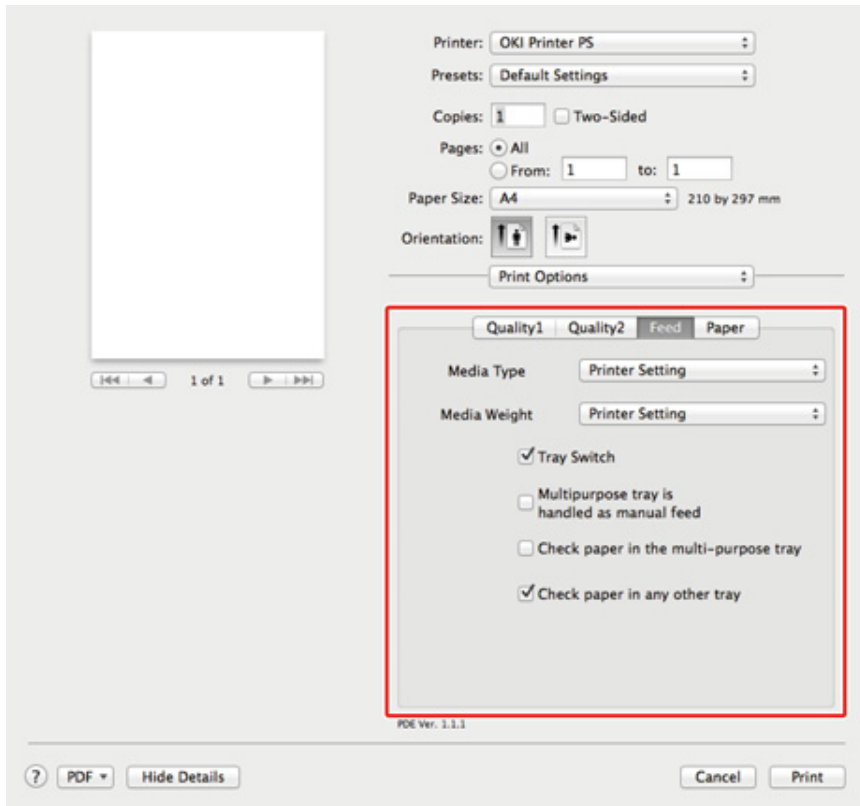

6 Click [Print].

Cancelling a Print Job

To cancel an ongoing print job, press the  (STOP) button on the operator panel.

To cancel jobs in the print queue, select jobs from the job list displayed on the touch panel to delete. To cancel printing, follow the steps below.



- The pages that are ready to be printed on this machine cannot be cancelled.
- If the operator panel indicates that printing is in progress for a long time, delete the print job from the computer.

- 1 Press the  (STATUS) button on the operator panel.
- 2 Press the [Device Information] tab.
- 3 Press [Job List].
- 4 Select the job you want to delete, and press [Delete].
- 5 Press [Yes] on the confirmation screen.

About Screens and Functions of Each Printer Driver

This section describes screens and functions of the printer drivers.

- Windows PCL Printer Driver
- Windows PS Printer Driver
- Mac OS X PS Printer Driver

Windows PCL Printer Driver

• [Setup] Tab

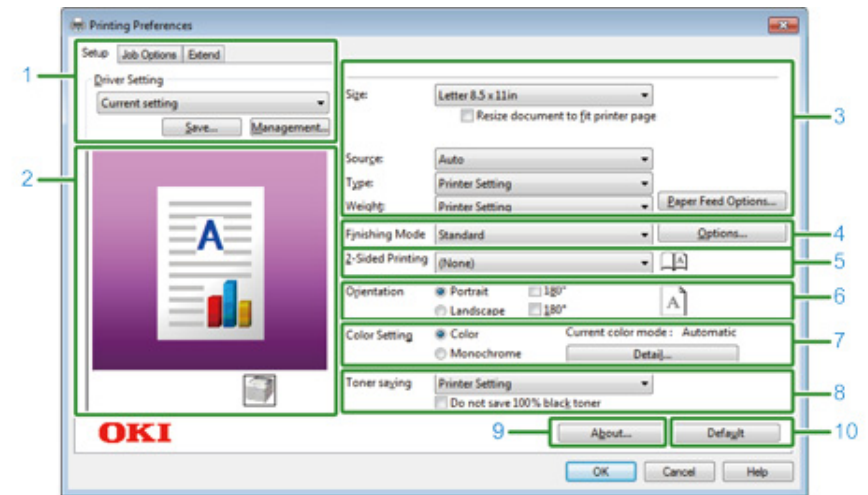

	Item	Description
1	Driver Setting	Saves your settings.
2	Image layout	Displays a sample image for the set layout.
3	Media	Specifies the paper size, type, weight, paper feed method, or other settings.
4	Finishing Mode	Specifies the multi-page printing, booklet printing, poster printing, or other settings.
5	2-Sided Printing (Duplex)	Specifies this setting when you want to perform duplex printing.
6	Orientation	Specifies the printing direction.
7	Color Setting	Switches between color printing and monochrome printing.
8	Toner saving	Decreases the print density to save toner.
9	About	Displays the version of the printer driver.
10	Default	Resets the settings on the tab to their default settings.

• [Job Options] Tab

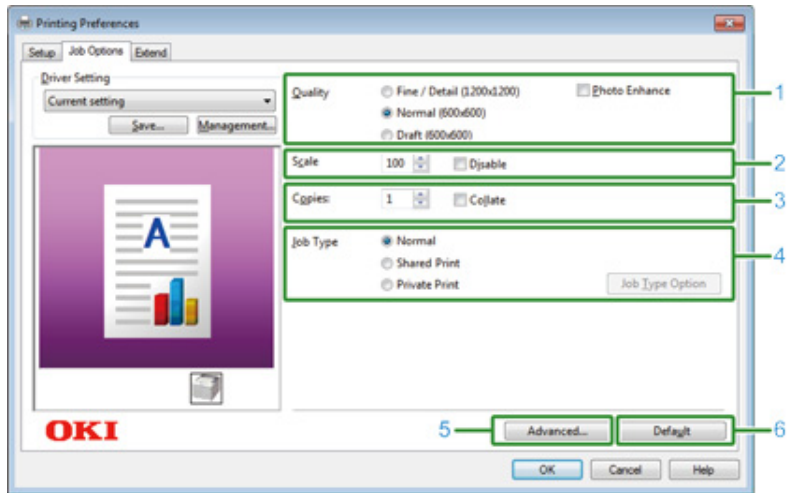

	Item	Description
1	Quality	Specifies the resolution for printing.
2	Scale	Specifies the enlargement/reduction rate for printing.
3	Copies	Specifies the number of copies to print.
4	Job Type	Specifies the print type.
5	Advanced	Sets other printing settings.
6	Default	Resets each setting value in the tab to its default setting value.

• [Extend] Tab

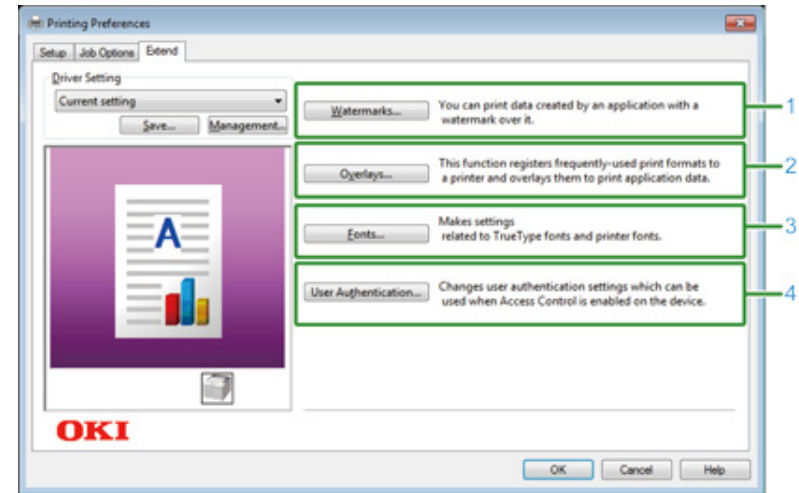

	Item	Description
1	Watermarks	Specifies when you want to use stamp print.
2	Overlays	Sets when printing print formats which are registered to the printer beforehand as overlays.
3	Fonts	Specifies TrueType fonts and printer fonts.
4	User Authentication	Specifies the user authentication.

Windows PS Printer Driver

• [Layout] Tab

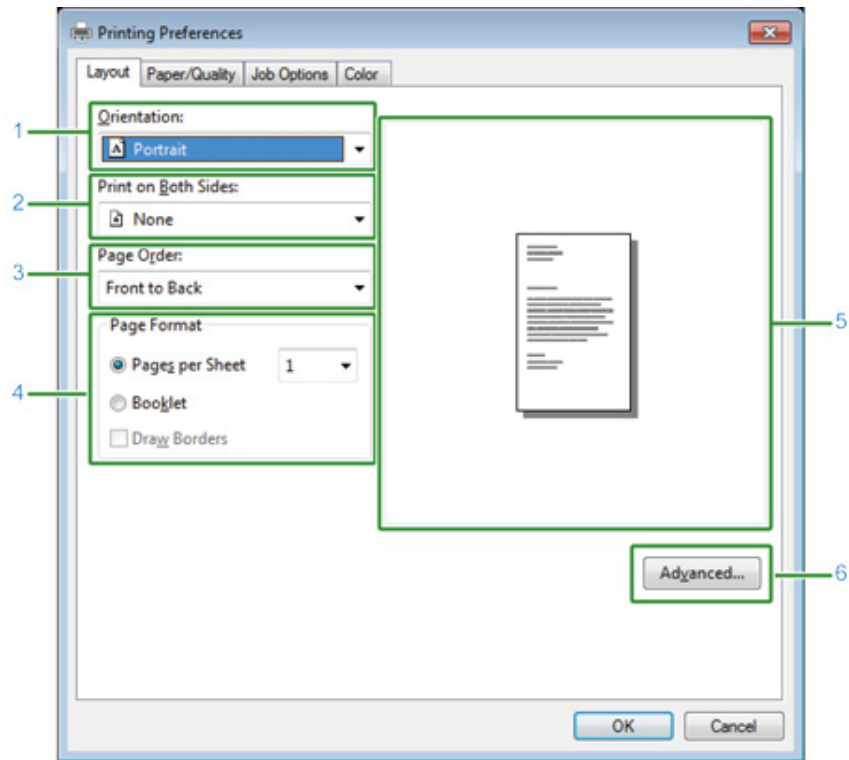

	Item	Description
1	Orientation	Specifies the printing direction.
2	Print on Both Sides	Specifies this setting when you want to perform duplex printing.
3	Page Order	Specifies a page order to print.
4	Page Format	Specifies the number of pages that is printed on a sheet of paper and booklet printing.
5	Image layout	Displays a sample image for the set layout.
6	Advanced	Allows you to set detailed settings for print quality and a paper size.

• [Paper/Quality] Tab

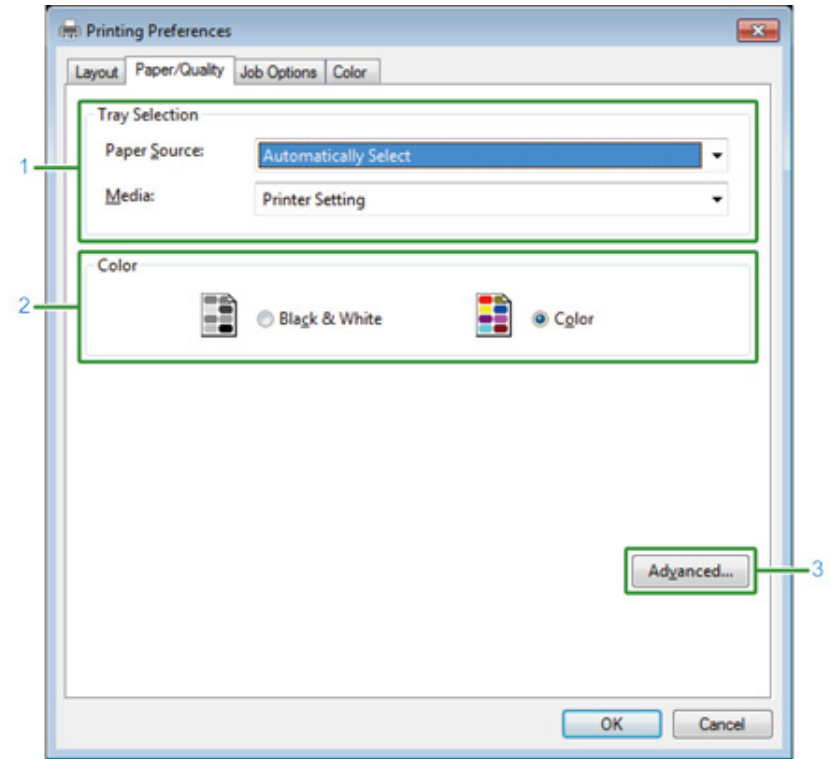

	Item	Description
1	Tray Selection	Changes the paper feed tray.
2	Color	Selects Color or Black & White.
3	Advanced	Allows you to set detailed settings for print quality and a paper size.

• [Job Options] Tab

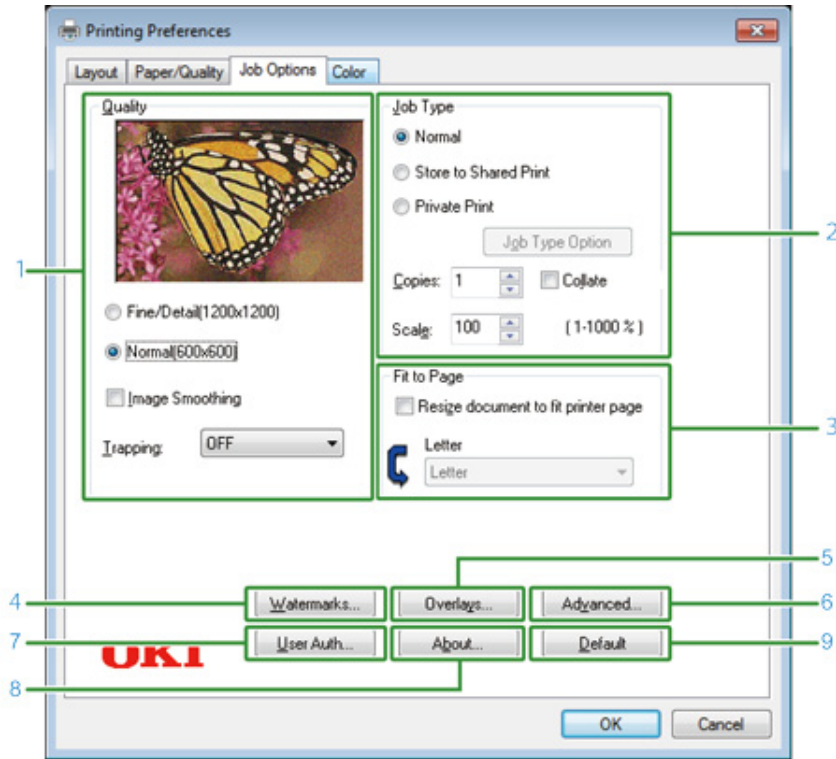

Item	Description
1	Quality
2	Job Type
3	Fit to Page
4	Watermarks
5	Overlays
6	Advanced
7	User Auth
8	About

Item	Description
9	Default

• [Color] Tab

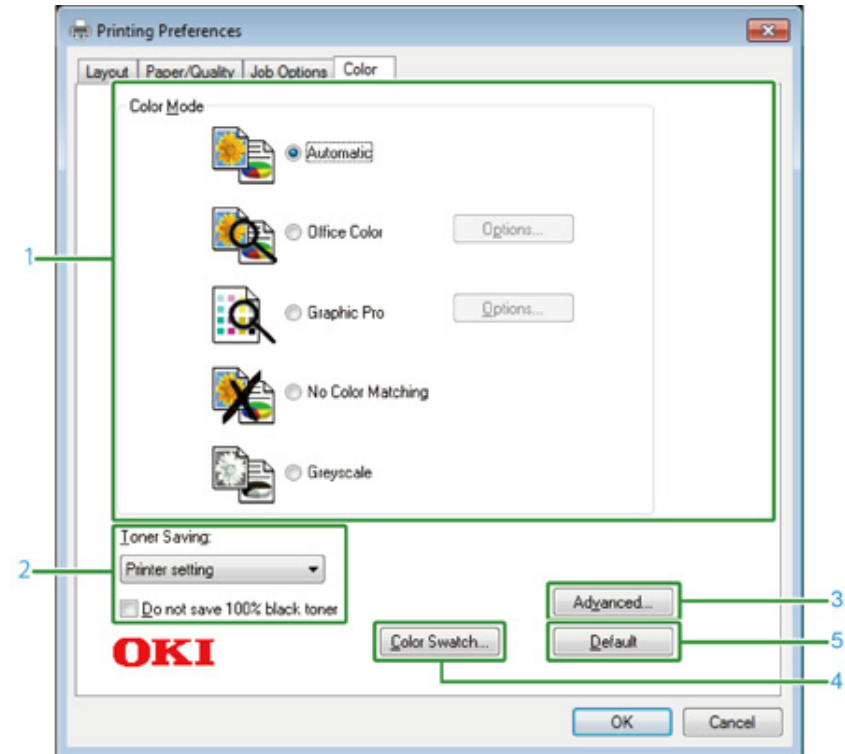

Item	Description
1	Color Mode
2	Toner Saving
3	Advanced
4	Color Swatch
5	Default

Mac OS X PS Printer Driver

• [Layout] Panel

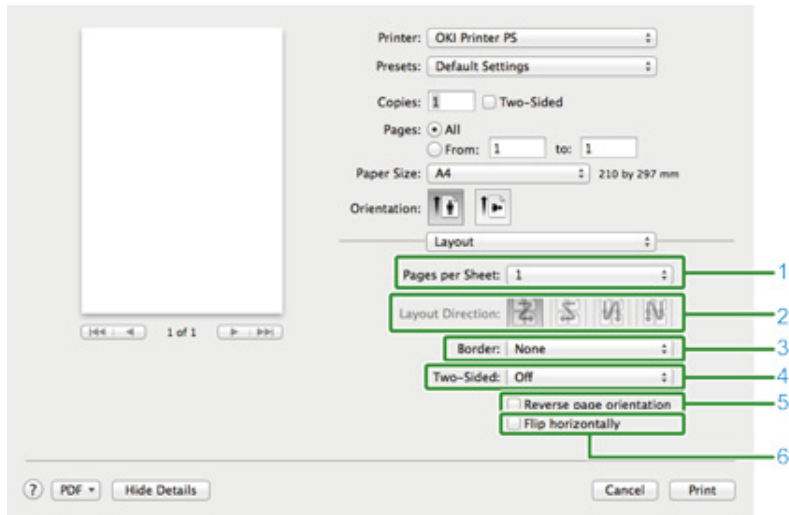

Item	Description
1	Pages per Sheet Selects the number of pages that is printed on a sheet of paper.
2	Layout Direction Specifies the layout that is applied when printing multiple pages on a sheet of paper.
3	Border Specifies a type of a boundary.
4	Two-Sided Specifies when performing duplex printing.
5	Reverse page orientation Reverses the direction of a page to print by selecting this check box.
6	Flip horizontally Flips left and right to print by selecting this check box.

• [Color Matching] Panel

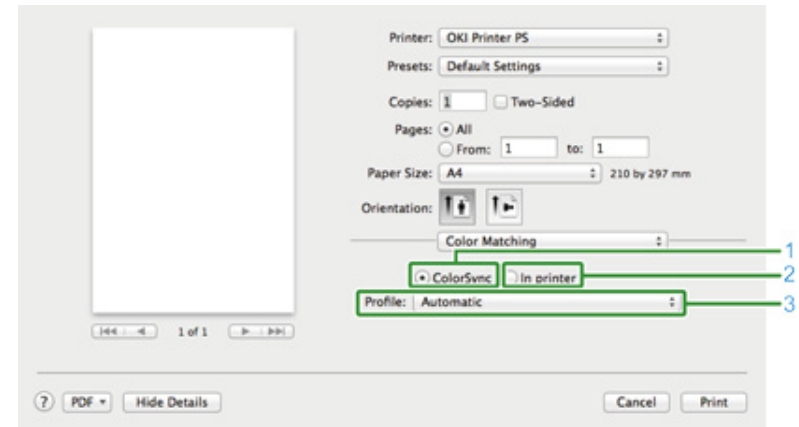

Item	Description
1	ColorSync Specifies the ColorSync function.
2	In printer Performs color matching with this machine.
3	Profile Specifies a profile.

• [Paper Handling] Panel

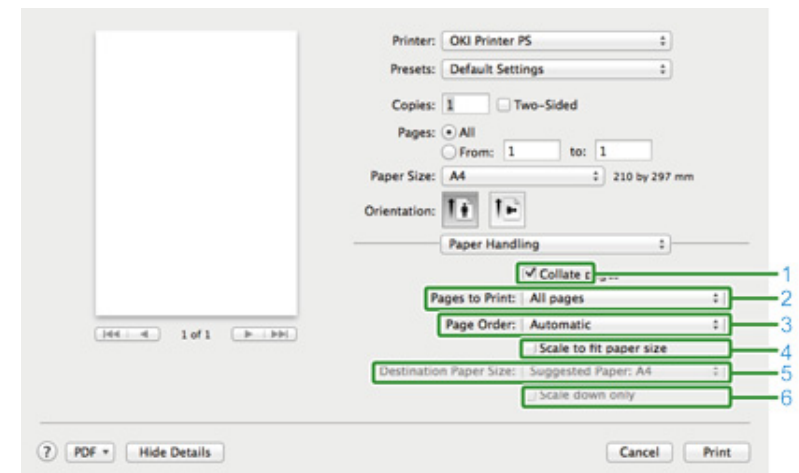

Item	Description
1	Collate pages Prints in units of copies by selecting this check box.

	Item	Description
2	Pages to Print	Specifies pages to print.
3	Page Order	Specifies a page order to print.
4	Scale to fit paper size	Prints to fit a paper size. Enlarges or reduces to fit the output paper size. Enlarges or reduces a document to fit the output paper size by selecting this check box.
5	Destination Paper Size	Selects the output paper size when the [Scale to fit paper size] check box is selected.
6	Scale down only	Only reduces a document to fit the output paper size by selecting this check box.

• [Paper Feed] Panel

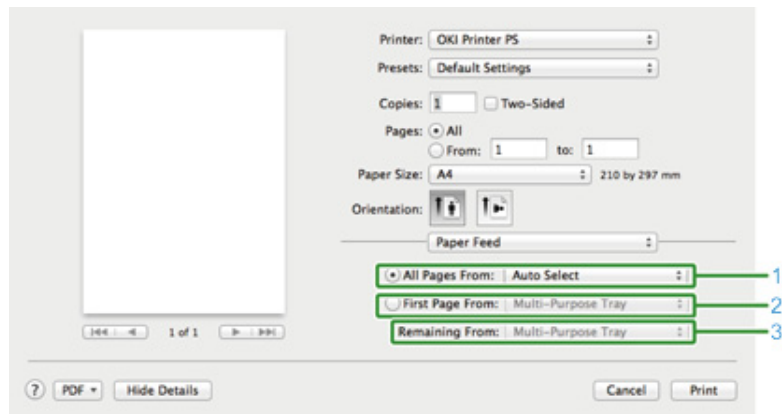

	Item	Description
1	All Pages From	Specifies the paper feed tray. If you specify [Auto Select], a tray is automatically selected.
2	First Page From	Select this setting to print only the first page from the specified tray.
3	Remaining From	Select this setting to print the remaining pages from the specified tray.

• [Cover Page] Panel

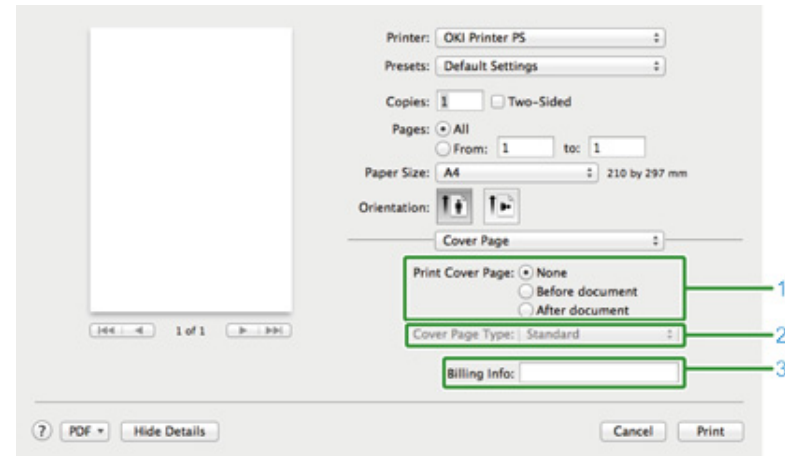

	Item	Description
1	Print Cover Page	Specifies the cover printing.
2	Cover Page Type	Specifies a string when printing the cover.
3	Billing Info	This function is not available.

• [Color] Panel

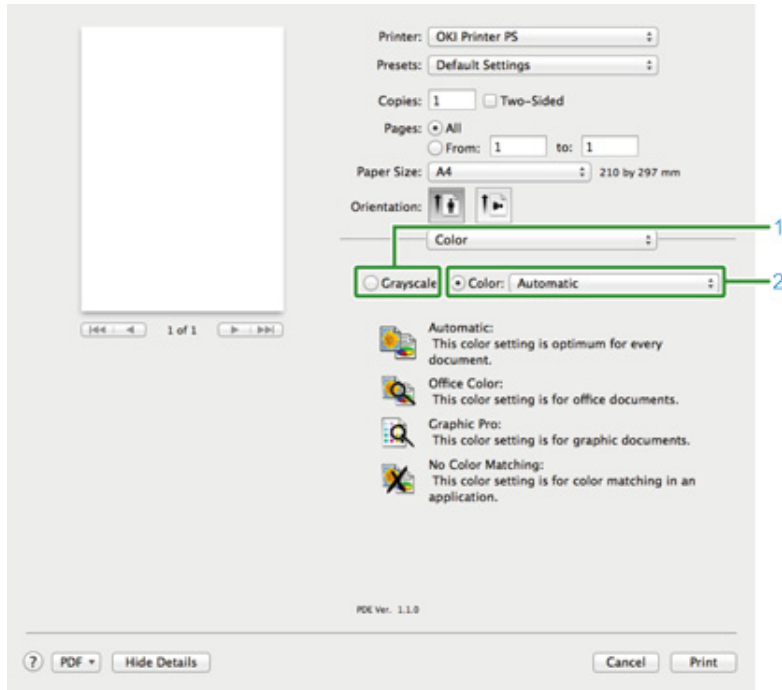

	Item	Description
1	Grayscale	Specifies to use monochrome printing.
2	Color	Specifies alignment to color mode when printing in color.

• [Print Options] Panel

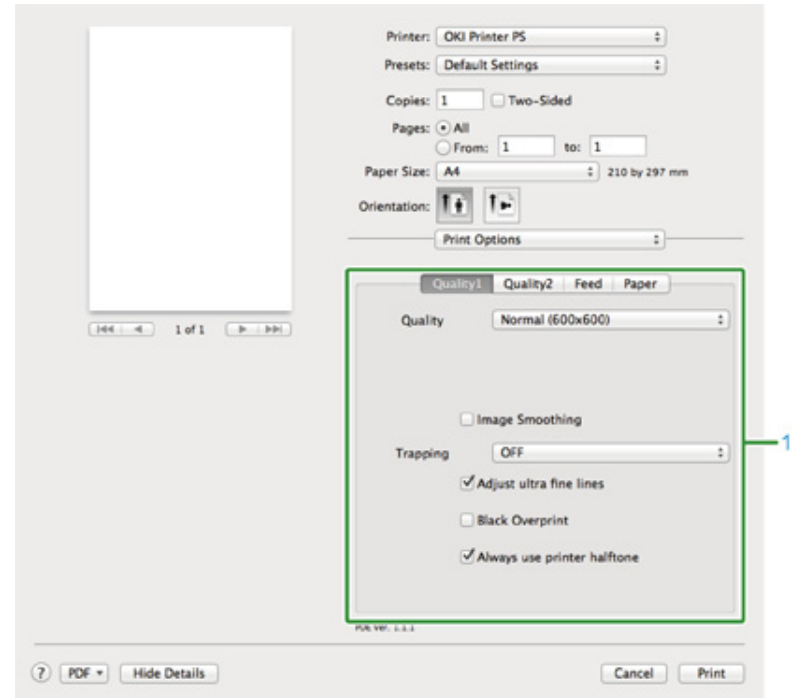

	Item	Description
1	Quality1, Quality2, Feed, Paper	Specifies the print quality, toner saving, paper type, etc.

• [User Authentication] Panel

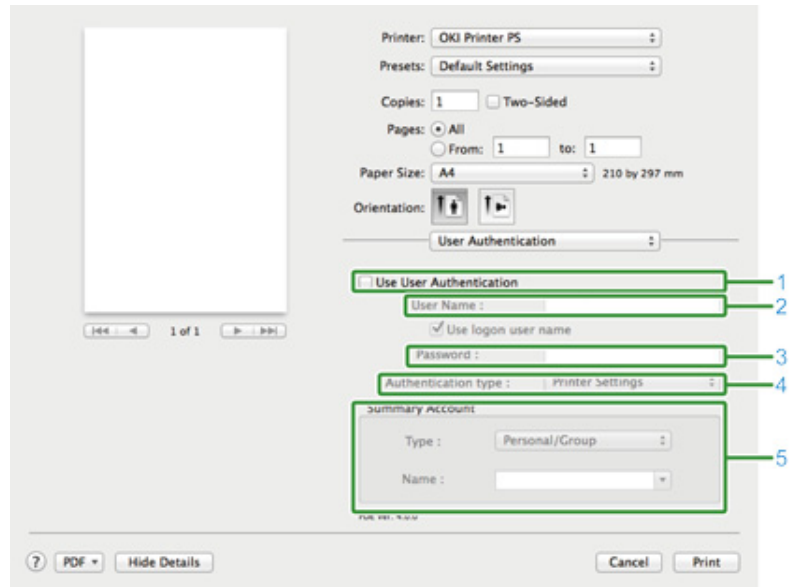

	Item	Description
1	Use User Authentication	Select this check box if you set user authentication when printing.
2	User Name	The user name for user authentication.
3	Password	The password for user authentication.
4	Authentication type	Specify an authentication type to be used.
5	Summary Account	Specify an account name and type.

• [Secure Print] Panel

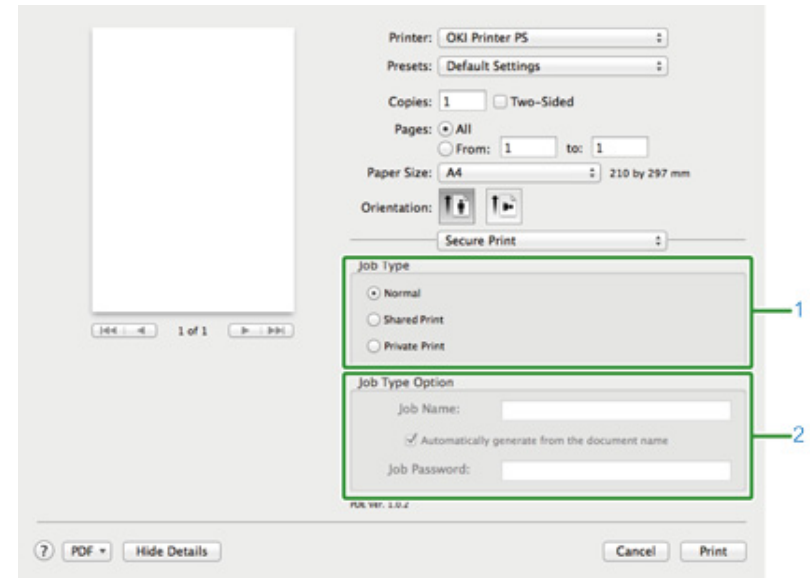

	Item	Description
1	Job Type	Specifies the job type. [Job Type Option] can be used if [Shared Print] or [Private Print] is selected.
2	Job Type Option	Specify a job name to be displayed on the touch panel and password required when printing.

• [Supply Levels] Panel

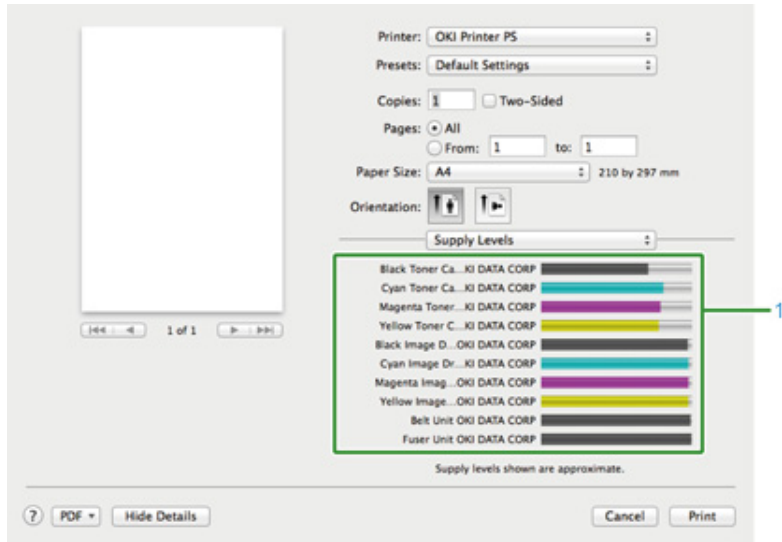

	Item	Description
1	Consumables	Displays the remaining amount of consumables.

Names and Functions of Screen Items for Print

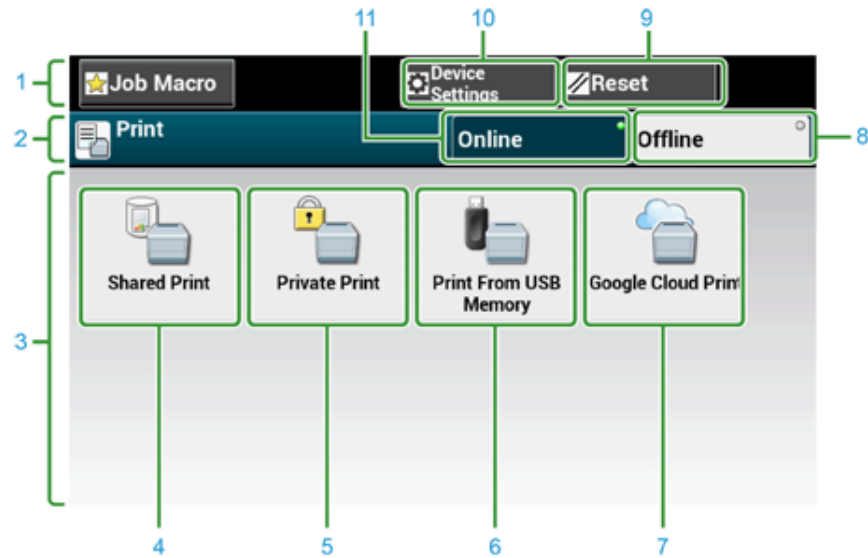

Item	Description
1	Stationary button area Displays buttons that appear on the screen at all times.
2	Title and operation guide area Displays the title of the current screen and provides guide for possible operations.
3	Main area Displays shortcut buttons for using certain print functions.
4	[Shared Print] Prints shared documents saved on the machine.
5	[Private Print] Prints private documents saved on the machine.
6	[Print From USB Memory] Prints a print data stored in USB Memory directly.
7	[Google Cloud Print] Prints a print data received from Google Cloud Print manually.
8	[Offline] Switches this machine offline.
9	[RESET] Returns the settings for the current print job to their default settings.
10	[Device Settings] Specifies various settings such as Administrator Setting.
11	[Online] Switches this machine online.

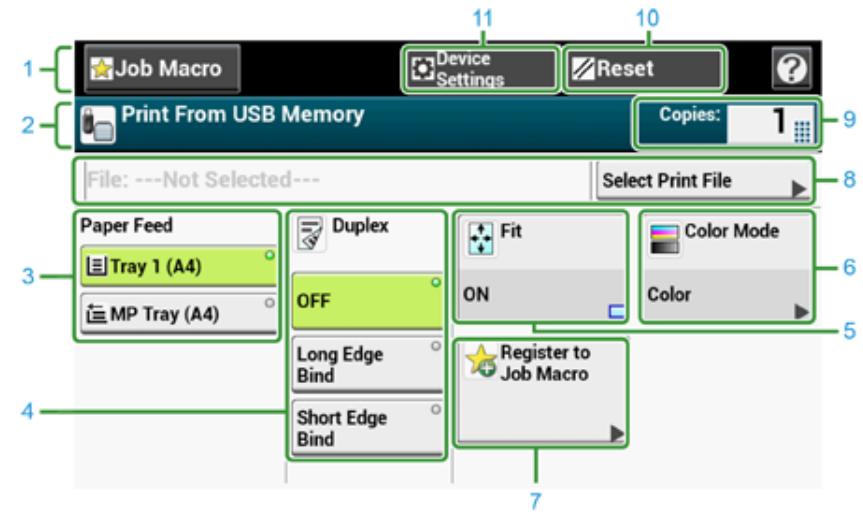

Item	Description
1	Stationary button area Displays buttons that appear on the screen at all times.
2	Title and operation guide area Displays the title of the current screen and provides guide for possible operations.
3	Paper Feed Specifies the tray to set the copy paper.
4	Duplex Prints on the both sides of paper.
5	Fit Prints adjusting the page size to fit the selected paper.
6	Color Mode Specifies color mode to copy a document.
7	Register to Job Macro Registers current settings to Job Macro.
8	Select Print file Select files to print.
9	Copies Specifies the number of copies to make.
10	Reset Returns the settings for the current copy job to their default settings.
11	Device Settings Specifies various settings such as Administrator Setting.

5

Maintenance

Replacing Consumables

Cleaning Each Part of the Machine

This category describes consumable replacements and cleaning to ensure a comfortable use of the machine for a longer life.





Replacing Consumables







This category describes how to replace toner cartridges and image drums.





- Cautions When Replacing Consumables
- Replacing the Toner Cartridges
- Replacing the Image Drum
- Replacing the Image Drum and Toner Cartridge at the Same Time

Cautions When Replacing Consumables

Observe the following cautions when replacing.

 WARNING	
	Do not throw the toner or toner cartridge into a fire. The toner will scatter, resulting in burns.
	Do not store a toner cartridge in a location where it is exposed to open flames. The toner may ignite, resulting in fire or burns.
	Do not vacuum spilled toner with an electric vacuum cleaner. Vacuuming spilled toner with an electric vacuum cleaner may result in ignition due to sparks from electric contacts or other reasons. If toner spills on the floor or other places, wipe the toner with a damp rag or other cloth.

 CAUTION	
	Some parts inside the machine become very hot. Do not touch the locations around a "CAUTION HOT" label. Burns may result.
	Keep toner cartridges out of the reach of children. If a child accidentally swallows toner, immediately seek medical advice.
	If you inhale toner, gargle with a large amount of water, and move to a place with fresh air. Seek medical advice if necessary.
	If toner lands on your hands or other areas of skin, wash thoroughly with soap and water.
	If toner gets into your eyes, immediately rinse with a large amount of water. Seek medical advice if necessary.

 CAUTION	
	If you swallow toner, spit it out. Seek medical advice if necessary.
	When handling a paper jam or replacing toner cartridges, use care not to let your clothes or hands get dirty with toner. If toner lands on your clothes, wash with cold water. If toner gets hot by washing with hot water or other methods, the toner will stain the fabric and become impossible to remove.
	Do not disassemble the image drum or toner cartridge. You may inhale the scattered toner, or the toner may land on your hands or clothes, making them dirty.
	Store used toner cartridges by putting them into a bag while using care not to scatter the toner.



- Use Oki Data genuine consumables to ensure optimum performance of the products.
- Charges for services for problems caused by the use of consumables other than Oki data genuine consumables are incurred, regardless of the warranty or in the maintenance contract. (Although the use of non-genuine consumables does not always result in problems, use extra care when using them.)

Replacing the Toner Cartridges

When the "[COLOR] Toner Low" message ("[COLOR]" indicates C (cyan), M (magenta), Y (yellow) or K (black)) which appears on the display screen, prepare a replacement toner cartridge.

When the "[COLOR] Toner Empty" appears and printing stops, replace the toner cartridge.



Even if the cyan (blue), magenta (red) or yellow toner cartridges run out, you can print in black and white by selecting [Monochrome] or [Grayscale]. However, please replace the toner cartridge quickly after it runs out, as not doing so may cause the image drum to be damaged.



- Have a new toner cartridge ready, as the print quality declines after more than one year following breaking the seal.
- If you replace the toner cartridge/image drum while it is being used, the toner consumption will not be counted normally.
- By opening and closing the output tray after the message "[COLOR] toner has run out" is displayed, you are able to print. Please replace the toner cartridge as failure to do so may damage the image drum.
- Toner powder may spill if you remove a toner cartridge before the toner runs out.

- 1 Prepare new toner cartridges.
- 2 Press the button (A) and open the output tray (a) completely.

 **CAUTION**

Burns may result.



The fuser unit is extremely hot. Do not touch it.

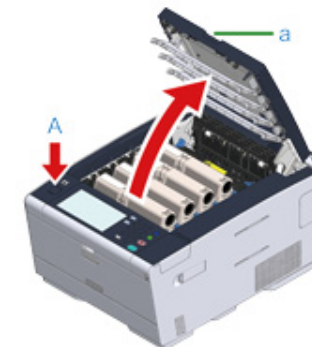

- 3 Identify an empty toner cartridge by its label color.
- 4 Pinch the tip of blue lever (b) of the toner cartridge and turn it toward you until the tip aligns on the lug of the cartridge.

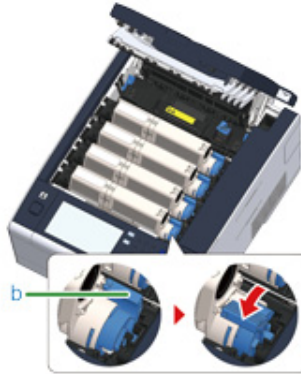

- 5 Lift the toner cartridge (c) from right side, and remove it from the machine.

WARNING

Burns may result.



Never throw a used image drum or toner cartridge into a fire. They may explode, and the toner inside may fly off and cause burns.



While removing consumables, be careful not to hit them to the LED head.

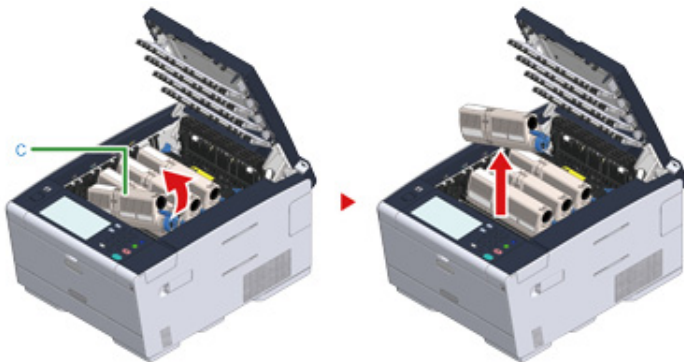

- 6 Unpack a new toner cartridge.

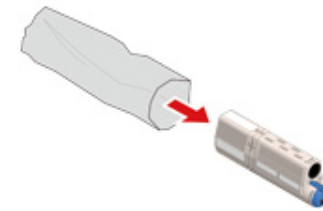

- 7 Shake the cartridge several times vertically and horizontally.

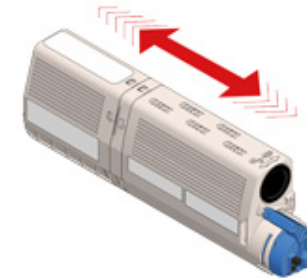

- 8 Remove the tape (d) from the toner cartridge.

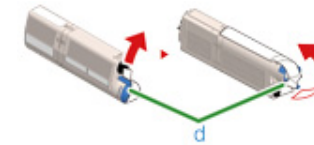

- 9 Insert a new toner cartridge (c) by aligning its left side indentation (e) with the protrusion (f) on the image drum so the toner cartridge and image drum color labels align. Then insert the right side gently into place.



Do not insert a toner cartridge without removing the tape.



- 10** Hold the cartridge, pinch the tip of blue lever (b) of the toner cartridge, and turn forward until the tip aligns on the lug of the cartridge.



- If you close the output tray without turning the blue lever when installing the toner cartridge into the image drum, it may cause a malfunction. Be sure to turn the blue lever until its top aligns on the lug in the back of the toner cartridge.
- If the toner cartridge is not securely attached, printing quality may deteriorate.

- 11** Wipe the lens of the LED head with a soft tissue paper lightly.

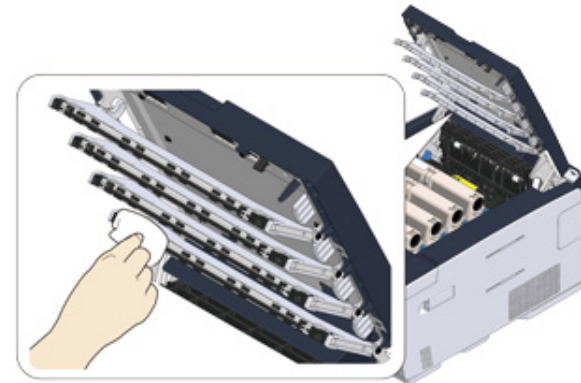

Do not use solvents, such as methyl alcohol or thinners. They damage the LED head.

- 12** Close the output tray (a) slowly and push the center of the output tray for confirmation.

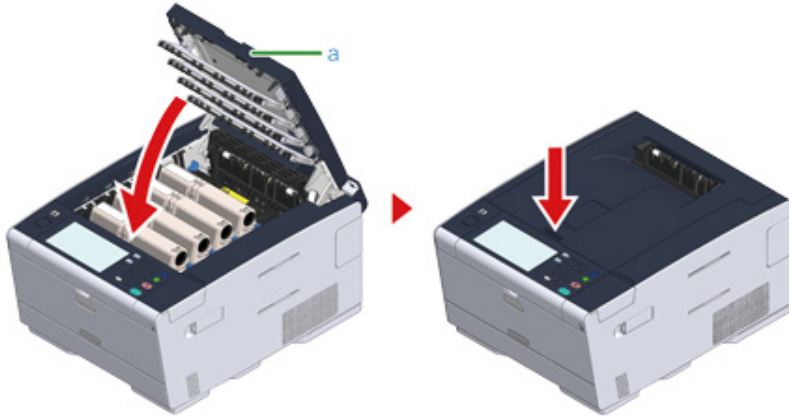

- 13** Please recycle toner cartridges.



If you have to dispose of used toner cartridges, put them into polyethylene bags or other container, and be sure to follow the regulations or instructions of your local government.

Replacing the Image Drum

When the "[COLOR] Image Drum Near Life" message appears on the display screen, prepare a replacement image drum. If you continue printing, the message "[COLOR] Image Drum Life" will be displayed and printing will stop.

When the "Please install new Image Drum Unit." message is displayed and printing stops, replace the image drum.

When using A4 paper (simplex printing), the estimated replacement cycle of an image drum is approximately 30,000 pages. This estimation assumes the standard use condition (three pages are printed at a time). Printing one page at a time reduces the drum lifetime approximately by half.

The actual number of printed pages may be less than half the above estimation depending on the printing conditions.



- The actual number of pages you can print with the image drum depends on how you use the machine. It may be less than half the above estimation depending on the printing conditions.
- Printing quality may deteriorate after 1 year following the unpacking of the toner cartridge. Replace the toner cartridge with a new one.
- Although opening and closing the output tray may extend the life of an image drum for a while, it is recommended to replace it soon after the "Install New image drum" message is displayed.
- When [Device Settings] > [Admin Setup] > [Manage Unit] > [System Setup] > [Near Life Status] on the touch panel is set to [Disable], the "[COLOR] Image Drum Near Life" message does not appear.
- Use Oki Data genuine consumables to ensure optimum performance of the products.
- Charges for services for problems caused by the use of consumables other than Oki data genuine consumables are incurred, regardless of the warranty or in the maintenance contract. (Although use of non-genuine consumables does not always result in problems, use extra care when using them.)

This section describes how to replace the image drum when you want to continue using the toner cartridge.



- If you use a new image drum with the toner cartridges currently in use, the remaining amount indication of the toner cartridges will not display correctly. The messages "[COLOR] Image Drum Near Life" or "[COLOR] Image Drum Life" may also be displayed soon after replacement.
- Use extra care when handling the image drum (the green cylinder), because it is fragile.
- Do not expose the image drum to direct sunlight or strong light (approximately 1,500 lux or more). Even under room lighting, do not leave the image drum for 5 minutes or more.



You can set when to display the "[COLOR] Image Drum Near Life" message. Press [Device Settings] > [Admin Setup] > [User Install] > [Drum Near Life Timing] on the touch panel to change the setting. Available values are from 500 to 3,000 (in 500 increments).

- 1 Prepare new image drum.
- 2 Press the button (A) and open the output tray (a) completely.

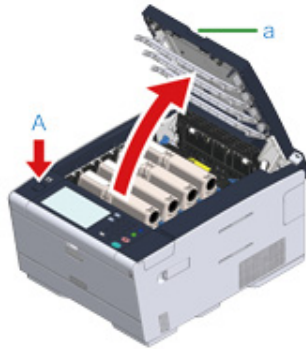

- 3 Identify the image drum that reached its lifetime by its label color.
- 4 Remove the image drum (b) from the machine and place the image drum on a flat surface.



While removing consumables, be careful not to hit them to the LED head.

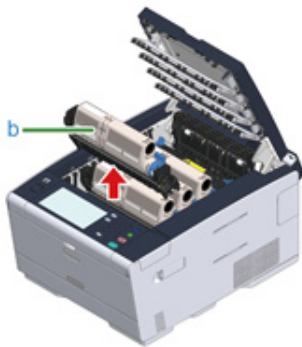

- 5 Hold the cartridge, pinch the tip of blue lever (c) of the toner cartridge, and turn it toward you until the tip aligns on the lug of the cartridge.

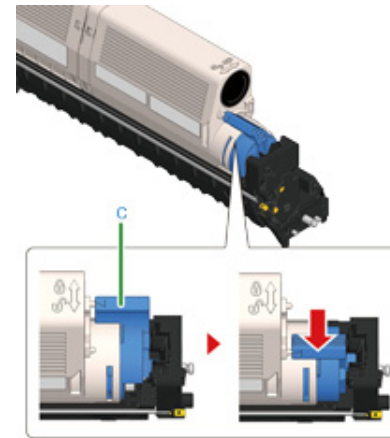

- 6 Lift the toner cartridge (d) from the right side, and remove it from the image drum.

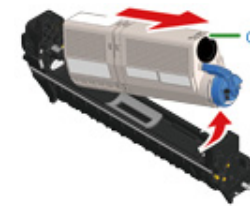

- 7 Unpack a new image drum and place it on a flat surface.

- 8 Remove the desiccant pack.

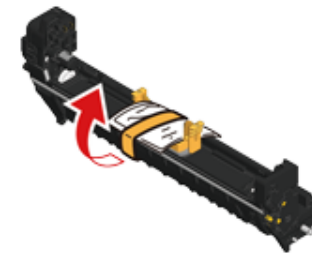

- 9 Remove the toner cover.

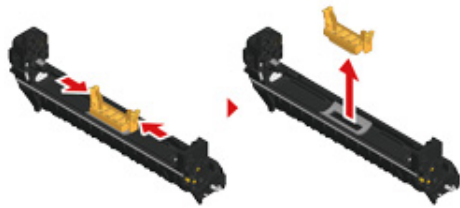

- 10 Insert the toner cartridge (d) removed in step 6 by aligning its left side indentation (e) with the protrusion (h) on the image drum so that the toner cartridge and image drum color label align. Then insert the right side gently into place.

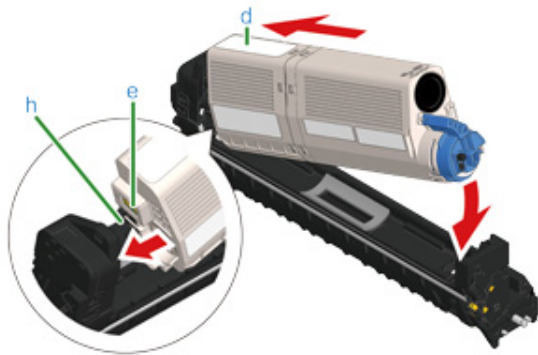

- 11 Hold the cartridge, pinch the tip of blue lever (g) of the toner cartridge, and turn forward until the tip aligns on the lug of the cartridge.

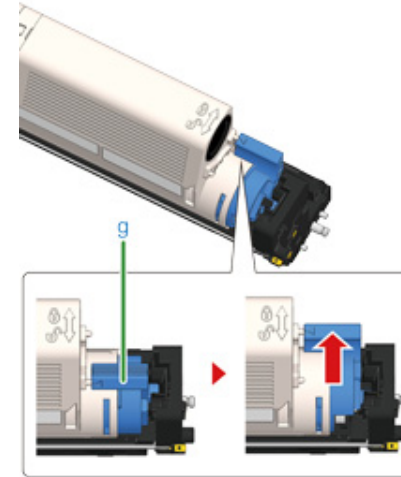

If you close the output tray without turning the blue lever when installing the toner cartridge into the image drum, it may cause a malfunction. Be sure to turn the blue lever until its top aligns on the lug in the back of the toner cartridge.

- 12 Check the label color of the new image drum and place the drum into the machine.

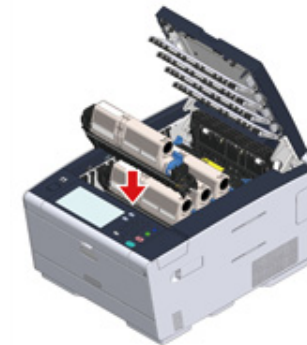

- 13** Close the output tray (a) slowly and push the center of the output tray for confirmation.

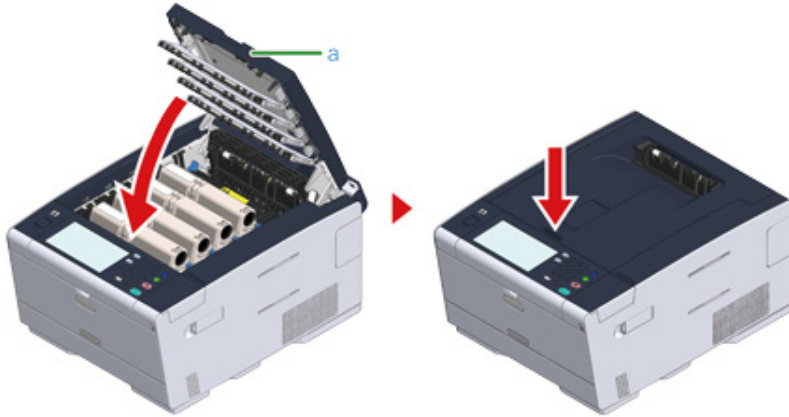

- 14** Please recycle image drums.



If you must dispose of an image drum, put it in a plastic bag or similar container and dispose of it in accordance with your municipality's ordinances or guidelines.

Replacing the Image Drum and Toner Cartridge at the Same Time

This section describes how to replace the image drum and toner cartridge with new ones at the same time.



- Use extra care when handling the image drum (the green cylinder), because it is fragile.
- Do not expose the image drum to direct sunlight or strong light (approximately 1,500 lux or more). Do not leave the image drum for 5 minutes or more even under room light.

- 1 Prepare new image drum and toner cartridge.
- 2 Press the button (A) and open the output tray (a) completely.

CAUTION

Burns may result.



The fuser unit is extremely hot. Do not touch it.

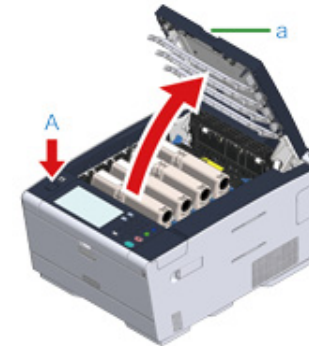

- 3 Identify an empty toner cartridge by its label color.
- 4 Remove the image drum (b) from the machine and place it on a flat surface.



While removing consumables, be careful not to hit them to the LED head.

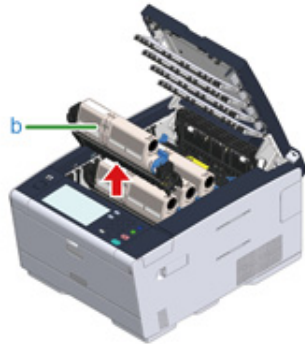

WARNING	Burns may result.	
<p>Never throw a used image drum or toner cartridge into a fire. They may explode, and the toner inside may fly off and cause burns.</p>		

5 Unpack a new image drum and place it on the flat surface.

6 Remove the desiccant pack.

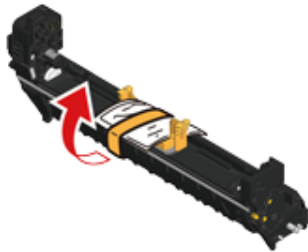

7 Remove the toner cover.

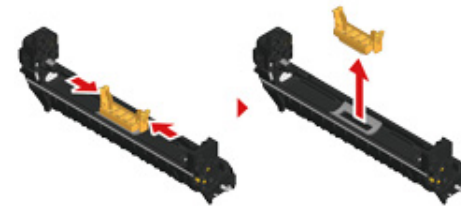

8 Unpack a new toner cartridge.

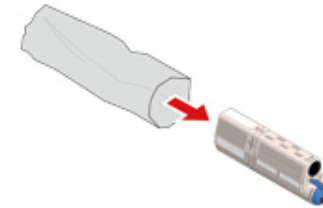

9 Shake the cartridge several times vertically and horizontally.

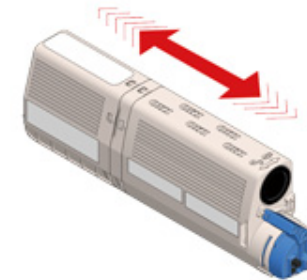

10 Remove the tape (c) from the toner cartridge.

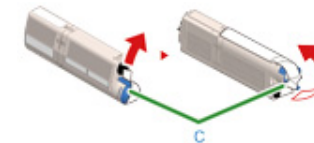

- 11** Insert a new toner cartridge (d) by aligning its left side indentation (e) with the protrusion (f) on the image drum so that the toner cartridge and image drum color label align. Then insert the right side gently into place.

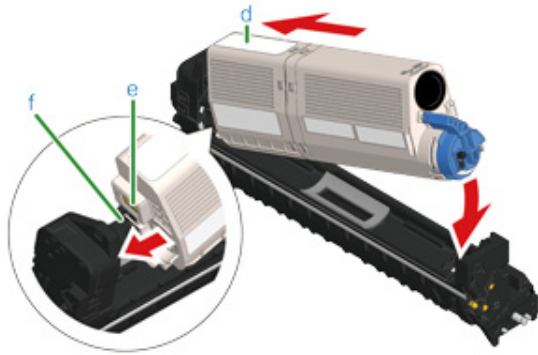

For the installation method, refer to "Replacing the Toner Cartridges".

- 12** Hold the cartridge, pinch the tip of blue lever (g) of the toner cartridge, and turn forward until the tip aligns on the lug of the cartridge.

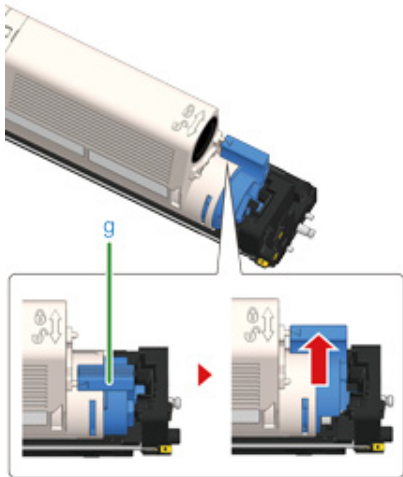

If you close the output tray without turning the blue lever when installing the toner cartridge into the image drum, it may cause a malfunction. Be sure to turn the blue lever until its top aligns on the lug in the back of the toner cartridge.

- 13** Check a label color of a new image drum and place the drum into the machine.

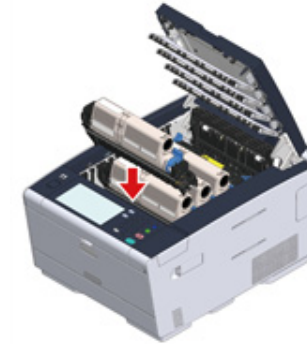

- 14** Close the output tray (a) slowly and push the center of the output tray for confirmation.

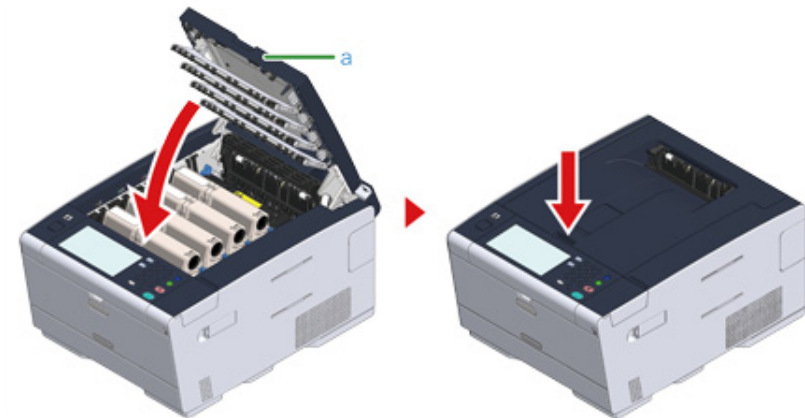

- 15** Please recycle image drums and toner cartridges.



If you must dispose of an image drum, put it in a plastic bag or similar container and dispose of it in accordance with your municipality's ordinances or guidelines.

Cleaning Each Part of the Machine

This section describes how to clean the machine and parts.

- Cleaning the LED Head

Cleaning the LED Head

Clean the LED head if vertical white lines appear, images are faded, or the periphery of letters are smudged in the printouts.



- Do not use solvents, such as methyl alcohol or thinners, because they may damage the LED head.
- Do not expose the image drum to direct sunlight or strong light (approximately 1,500 lux or more). Even under room lighting, do not leave the image drum for 5 minutes or more.

1 Press the button (A) and open the output tray (a) completely.

 **CAUTION**

Burns may result.



The fuser unit is extremely hot. Do not touch it.

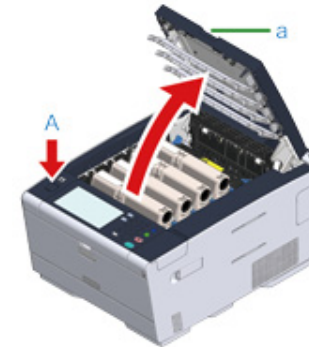

2 Wipe the four lenses of the LED heads with a soft tissue paper lightly.

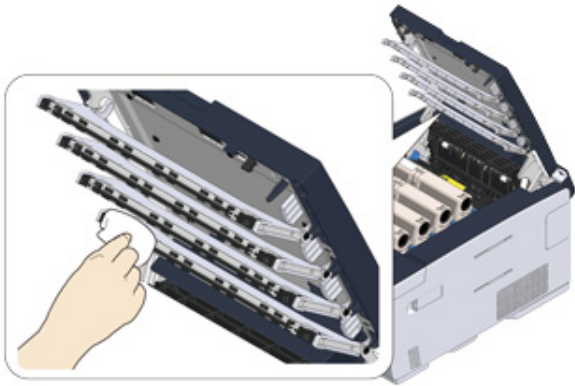

3 Close the output tray (a) slowly and push the center of the output tray for confirmation.

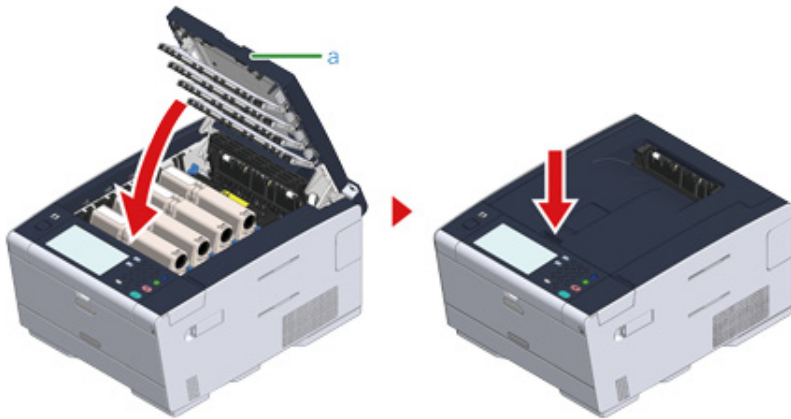

6

Troubleshooting

If Paper Jams Occur

Print Problems

If an Error Message is Displayed on the Operator Panel

If Paper Jams Occur

This section describes how to handle when a paper jam occurs. Check the error code on the operator panel and see the corresponding page.

- If the Error Code is "370", "371", "372"
- If the Error Code is "380", "381", "382", "385", "389"
- If the Error Code is "390"
- If the Error Code is "391", "392", "393"
- If the Error Code is "409"

If the Error Code is "370", "371", "372"

- 1 Press the button (A) and open the output tray (a) completely.

CAUTION

Burns may result.



The fuser unit is extremely hot. Do not touch it.

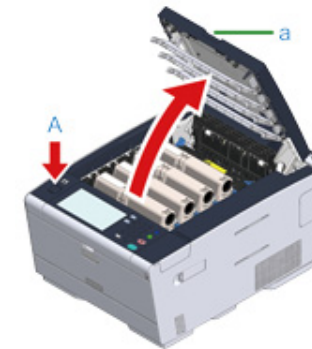

- 2 Remove the four image drums from the machine and place the image drums on a flat surface.



While removing consumables, be careful not to hit them to the LED head.

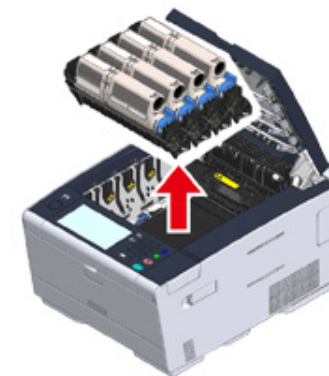

- 3 Cover the removed image drums with paper so that the image drums are not exposed to light.

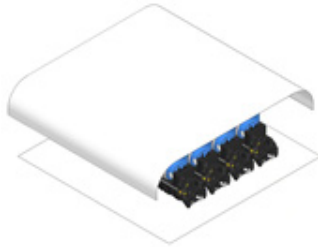

- 4 Pull out the jammed paper gently to the rear of the machine (the direction of the arrow) if an edge of jammed paper can be seen.



- 5 If paper jams in the fuser unit, press the jam release lever (b) on the fuser unit and slowly pull the jammed paper toward you.



- 6 Tilt back the lock levers on the both sides of the fuser unit toward you.

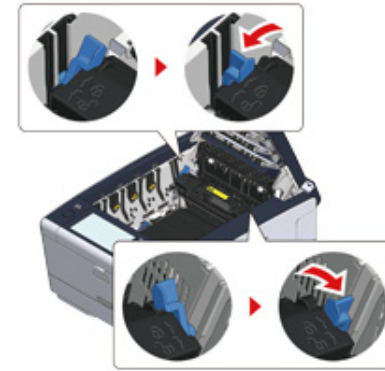

- 7 Hold the fuser unit handle and lift the fuser unit out of the machine.

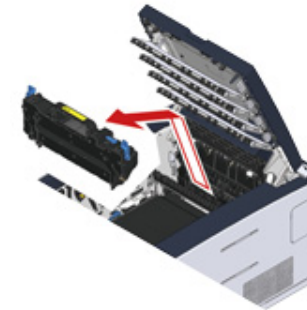

- 8 Tilt back the lock levers on the both sides of the belt unit toward you and remove the belt unit by holding the lock levers.

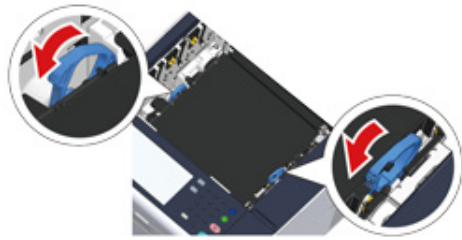

- 9 Remove the jammed paper slowly by pulling the edge of paper.

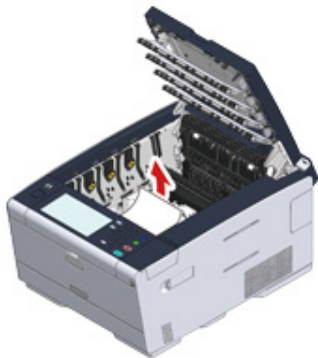

- 10 Hold the lock levers of belt unit and place the belt unit into the machine.

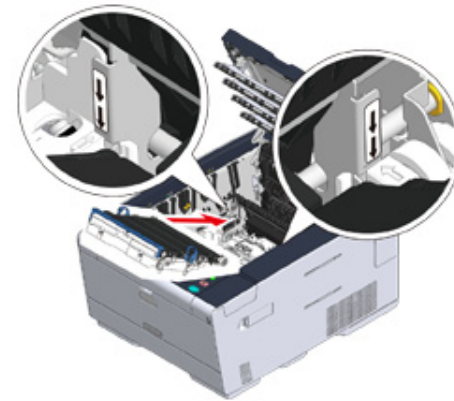

- 11 Turn the lock levers on the both sides of the belt unit forward.



- 12** Hold the fuser unit handle and place the fuser unit into the machine.

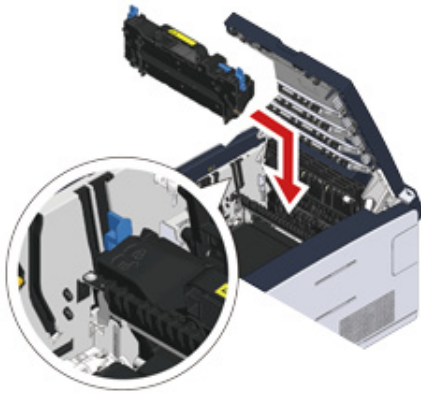

- 13** Tilt the lock levers on the both sides of the fuser unit.

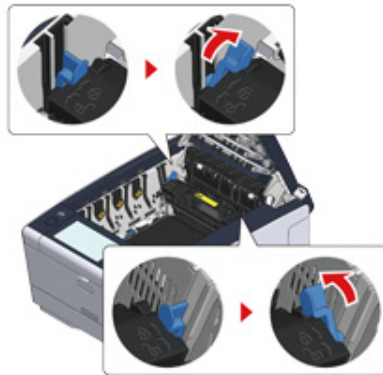

- 14** Replace the four image drums into the machine

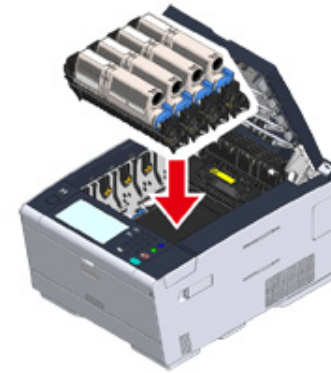

- 15** Close the output tray (a) slowly and push the center of the output tray for confirmation.

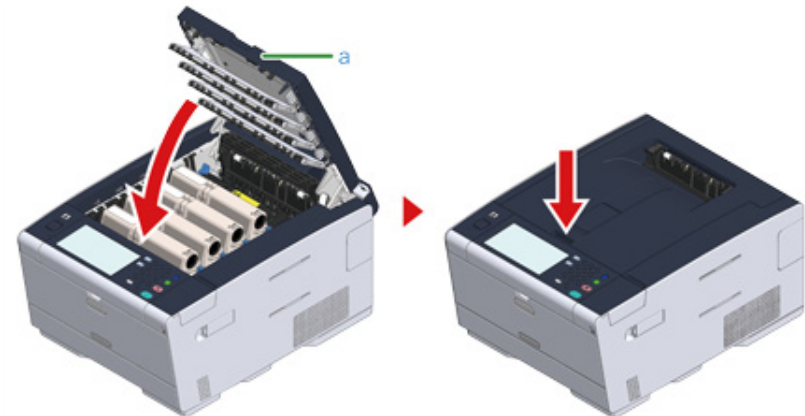

Task is complete.

If the Error Code is "380", "381", "382", "385", "389"

- 1 Press the button (A) and open the output tray (a) completely.

CAUTION

Burns may result.



The fuser unit is extremely hot. Do not touch it.

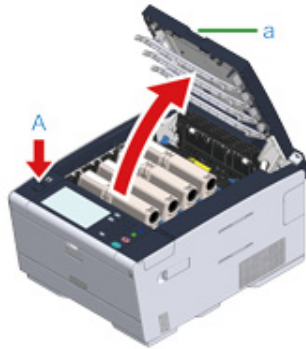

- 2 Remove the four image drums from the machine and place the image drums on a flat surface.



While removing consumables, be careful not to hit them to the LED head.

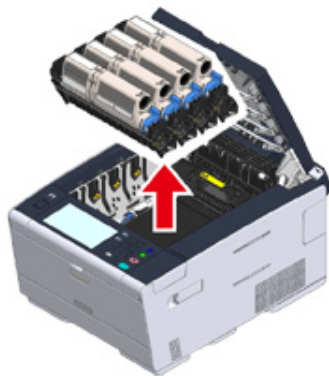

- 3 Cover the removed image drums with paper so that the image drums are not exposed to light.

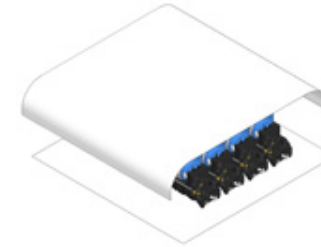

- 4 Remove the jammed paper slowly by pulling the edge of paper.

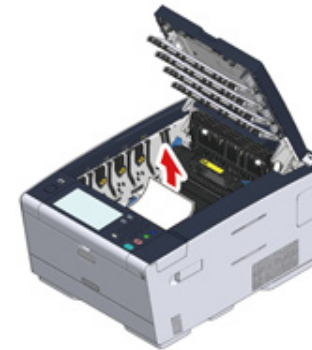

- 5 If paper jams in the fuser unit, press the jam release lever on the fuser unit and slowly pull the jammed paper toward you.



- 6 Tilt back the lock levers (c) on the both sides of the fuser unit toward you.

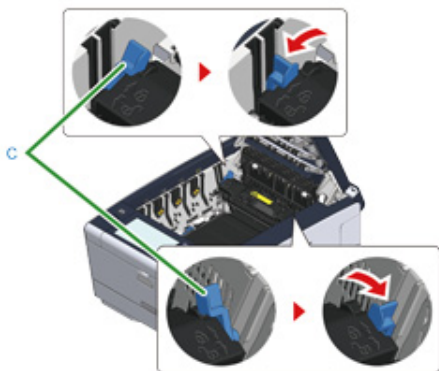

- 7 Hold the fuser unit handle and lift the fuser unit out of the machine.

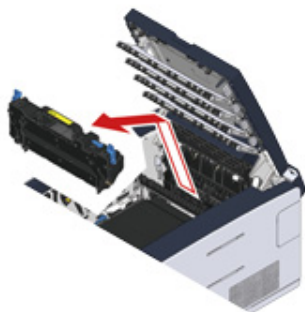

- 8 If jammed paper remains in the machine, hold the both sides of the paper to remove it gently.

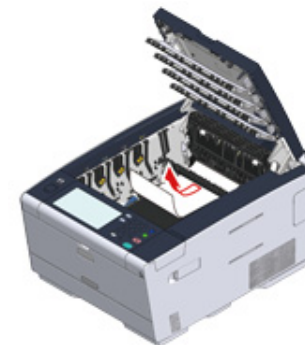

- 9 Hold the fuser unit handle and place the fuser unit into the machine.

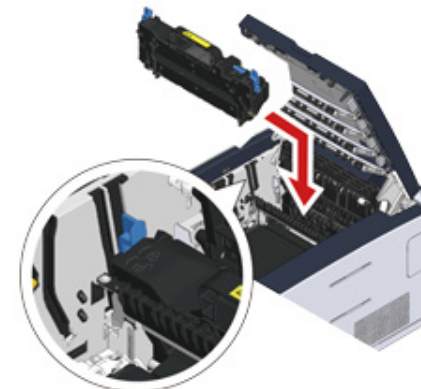

- 10 Tilt the lock levers (c) on the both sides of the fuser unit.

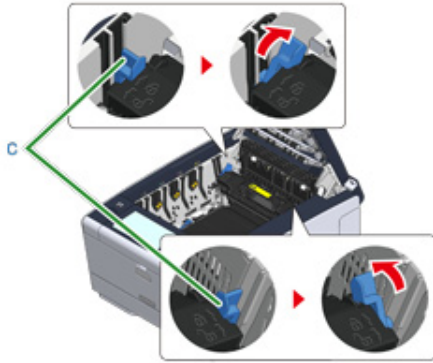

- 11 Put all four image drums back into the machine.

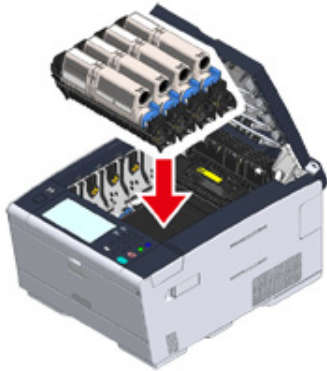

- 12 Close the output tray (a) slowly and push the center of the output tray for confirmation.

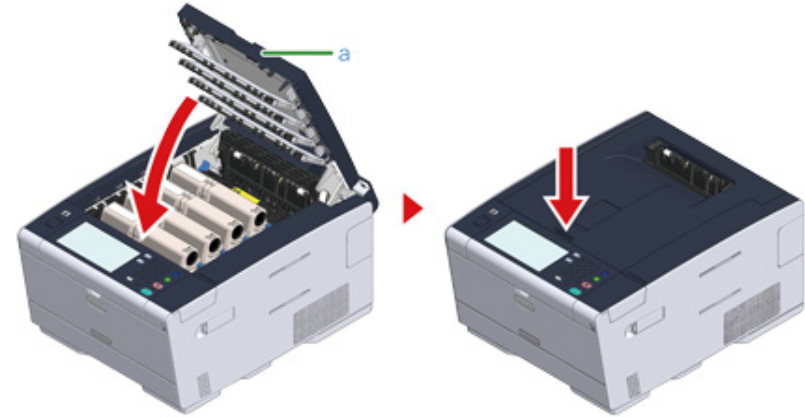

Task is complete.

If the Error Code is "390"

- 1 If paper is loaded on the MP tray, remove the paper.



- 2 Press the button (A) and open the output tray (a) completely.

CAUTION

Burns may result.



The fuser unit is extremely hot. Do not touch it.

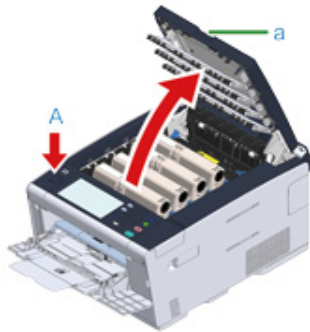

- 3 Remove the four image drums from the machine and place the image drums on a flat surface.



While removing consumables, be careful not to hit them to the LED head.

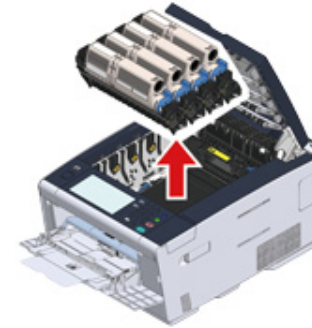

- 4 Cover the removed image drums with paper so that the image drums are not exposed to light.

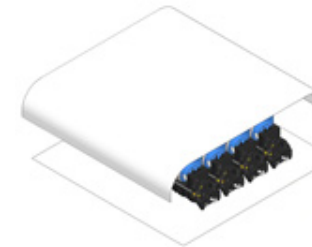

- 5 Open the transparent cover inside the machine, remove the jammed paper slowly by pulling the edge of paper.

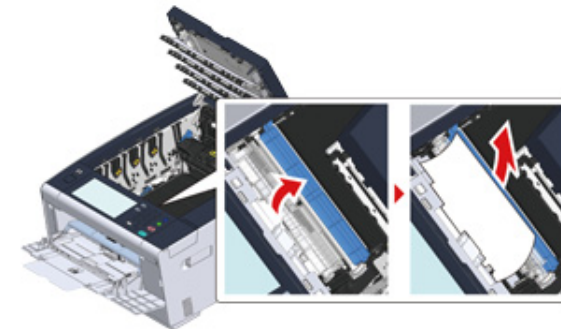

- 6 Put all four image drums back into the machine.

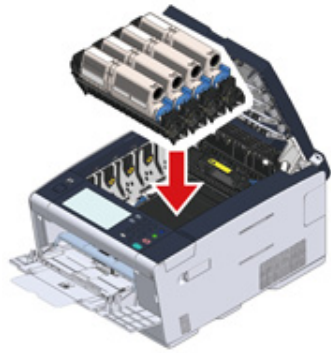

- 7 Close the output tray (a) slowly and push the center of the output tray for confirmation.

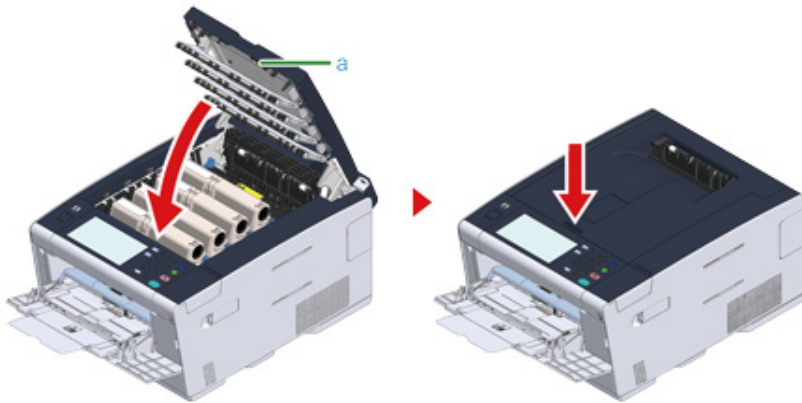

- 8 When loading paper on the MP tray, load the paper with the print side face up.

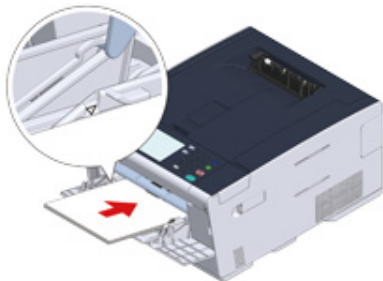

Task is complete.

If the Error Code is "391", "392", "393"

A paper jam has occurred while feeding paper from a paper tray.



If paper jams occur frequently, clean the paper feed rollers. For details, refer to "Cleaning the Paper Feed Rollers (Tray 1/Tray 2/Tray 3) (Advanced Manual)".

This procedure uses Tray 1 as an example.

- 1 Pull out the cassette of the indicated tray.



- 2 Remove the jammed paper.



If jammed paper cannot be found, check the positions of paper guides and paper stopper in the tray and ensure that paper is correctly loaded.

- 3 Replace the paper cassette into the machine.



- 4 Press the button (A) and open the output tray (a) completely.

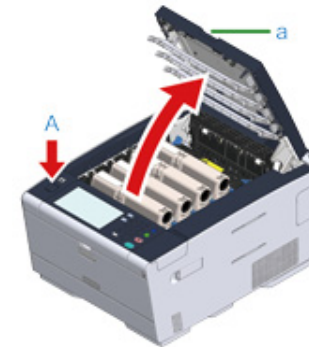

- 5 Close the output tray (a) slowly and push the center of the output tray for confirmation.

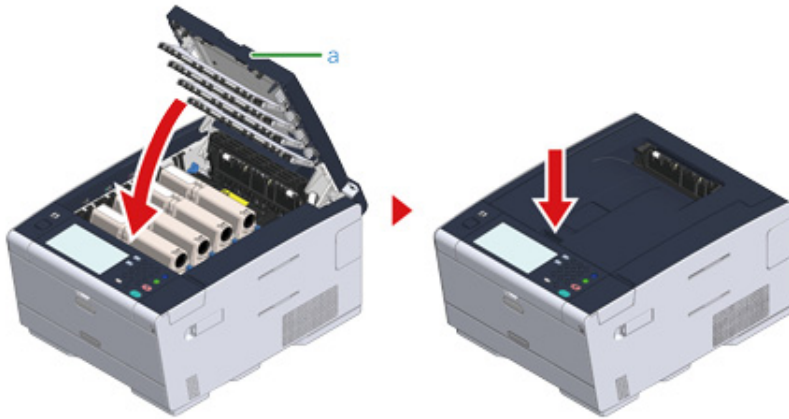

Task is complete.



Opening and closing the output tray starts printing.

If the Error Code is "409"

- 1 Close the rear output tray.



- 2 Press the button (A) and open the output tray (a) completely.



CAUTION

Burns may result.



The fuser unit is extremely hot. Do not touch it.

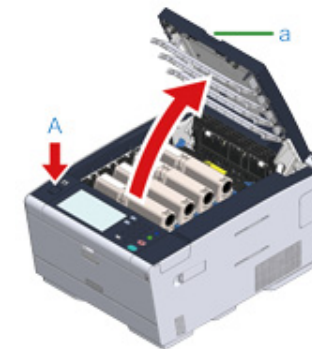

- 3 Remove the four image drums from the machine and place the image drums on a flat surface.



While removing consumables, be careful not to hit them to the LED head.

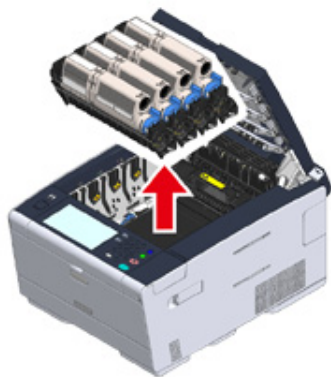

- 4** Cover the removed image drums with paper so that the image drums are not exposed to light.

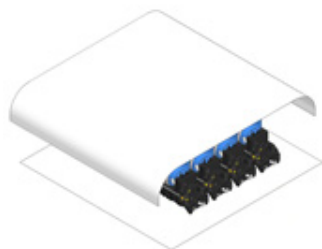

- 5** Remove the jammed paper slowly by pulling the edge of paper.



- 6** If paper jams in the fuser unit, press the jam release lever on the fuser unit and slowly pull the jammed paper toward you.



- 7** Tilt back the lock levers on the both sides of the fuser unit toward you.

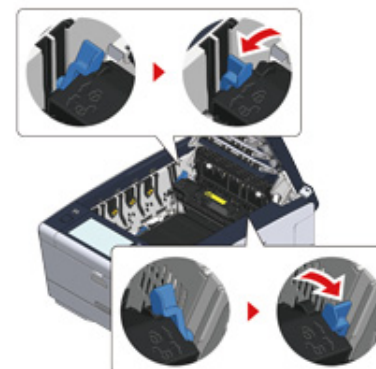

- 8 Hold the fuser unit handle and lift the fuser unit out of the machine.

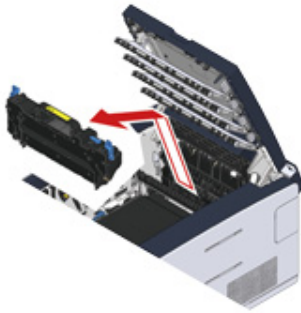

- 9 Tilt the lock levers on the both sides of the belt unit toward you and remove the belt unit by holding the lock levers.

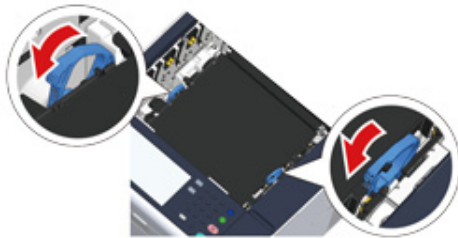

- 10 Remove the jammed paper slowly by pulling the edge of paper.

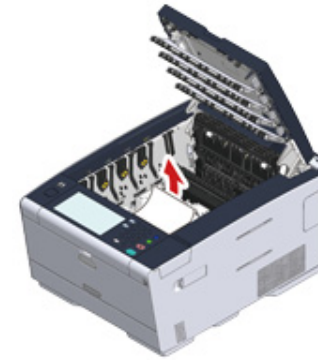

- 11 Hold the lock levers of belt unit and place the belt unit into the machine.

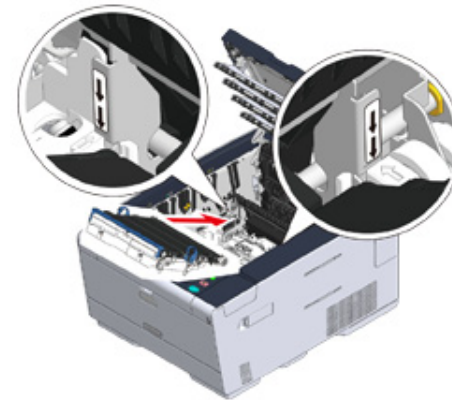

- 12** Turn forward the lock levers on the both sides of the belt unit.

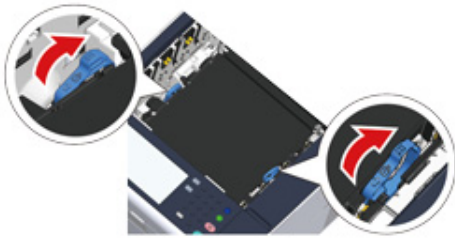

- 13** Hold the fuser unit handle and place the fuser unit into the machine.

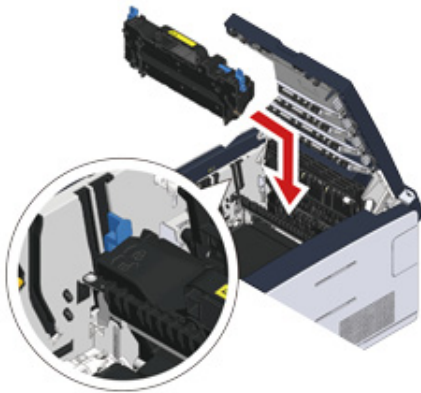

- 14** Tilt the lock levers on the both sides of the fuser unit.

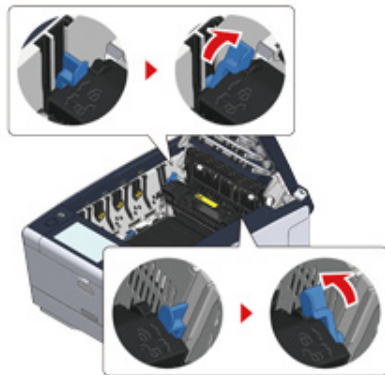

- 15** Put all four image drums back into the machine.

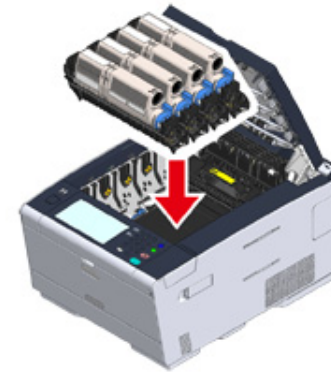

- 16** Close the output tray (a) slowly and push the center of the output tray for confirmation.

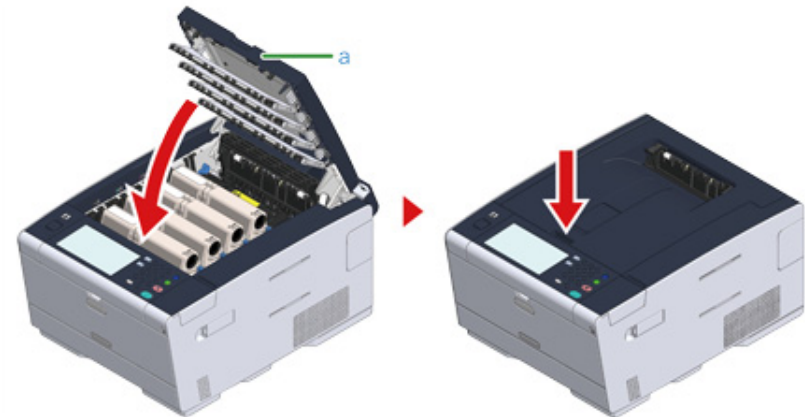

Task is complete.

Print Problems

This section describes problems with printing from a computer.











- If you cannot solve a problem with the following solutions, contact your dealer.
- For problems caused by an application, contact the manufacturer of the application.

• Unable to Print

Unable to Print

• Common to Windows and Mac OS X

Cause	Solution	Reference
The machine is in Sleep mode or Deep Sleep mode.	Press the  (POWER SAVE) button to enter standby status.	 Saving Power Consumption with the Power Save Function
The machine is turned off.	Turn the machine on.	 Turning the Machine On
A LAN cable or USB cable is unplugged.	Check that the cable is plugged into the machine and computer properly.	 Connecting a LAN Cable/USB Cable
There may be a problem with a cable.	Replace the cable with a new cable.	-
The machine is offline.	Press the  (PRINT) button, and then select [Online].	-
An error message is displayed on the touch panel.	Check the error messages displayed on the touch panel or press [?] on the touch panel.	 Error Message List
The interface setting is disabled.	Whether there is a consistency with the machine's settings and the network connection environment, check the settings of the interface that you are using on the operator panel.	 Connecting a LAN Cable/USB Cable
There is a problem with the print function.	Check if the menu map can be printed.	 Checking the Information of the Machine (Advanced Manual)
The power switch LED lamp quickly flashes at approximately 0.3-second intervals.	A malfunction may occur in the machine. Unplug the power cord immediately, and then contact your dealer.	-



• For Windows

Cause	Solution	Reference
The machine is not set as the default printer.	Set the machine as the default printer. Right-click the [OKI C542 *] icon on the [Devices and Printers] folder, and then select [Set as Default Printer]. * Indicates the driver type. (ex. PCL6/PS/XPS)	-

Cause	Solution	Reference
The output port of the printer driver is incorrect.	Select the output port for connecting the LAN cable or USB cable.	-
The machine is processing data from another interface.	Wait until printing is complete.	-
[Received invalid data] is displayed on the touch panel and the machine does not print.	Press [Device Settings], select [Admin Setup] > [Print Setup] > [Print menu] > [Printer Adjust] > [Timeout Injob] on the touch panel, and then select a longer time. The factory default setting is 40 seconds.	-

If an Error Message is Displayed on the Operator Panel

If an error occurs in this machine, an error message and/or an error code (a 3-digit number) is displayed on the touch panel and  (STATUS) on the operator panel blinks or lights up.

Press [Details] and clear the error following the onscreen instructions.

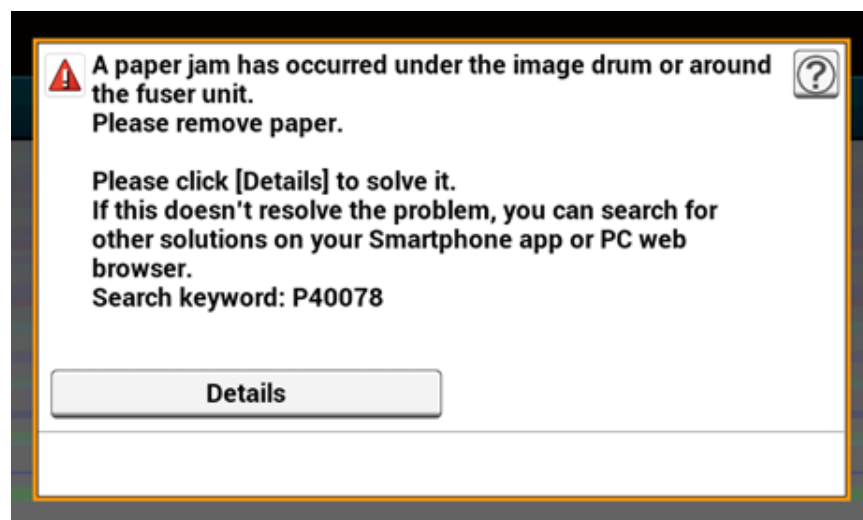

- Error Message List

Error Message List

Wait a moment. Network initializing ...

The network is being initialized.
Wait for a while until the machine connects to the network.

Checking File System

File system in the hard disk is being checked. Wait for a while.

Inspection is required. PU Flash Error

Turn the machine off, and then back on. If the same error occurs, contact your dealer.

Inspection is required. PU Communication Error

Turn the machine off, and then back on. If the same error occurs, contact your dealer.

Offline Mode

Press [Print] > [Online] on the touch panel. The  (STATUS) button turns off when the machine turns online.

Data present.

Data remains unprinted. Wait for a while and if the message does not disappear, check the data.

Deleting data.

The job was cancelled or user is unauthorized. Wait for a while.

Warming up.

The machine is adjusting the temperature of the fuser unit. Wait for a while.

Preparing ...

Color registration and density are being adjusted. Wait for a while.

Wait a moment. Executing maintenance.

The programs on the machine are being updated.
Do not turn the machine off until the update completes.
The machine automatically restarts after the update completes.

Toner Low.

The toner indicated on the screen is low. Have a new toner cartridge ready.

Waste Toner Full Replace with new Toner Cartridge.

Waste toner is full. Replace the toner cartridge with a new one.
C: Cyan (blue), M: Magenta (red)

C Non Recommended Toner.

An optimum C (Cyan, blue) toner cartridge is not installed.
Use a toner cartridge that matches your machine.

M Non Recommended Toner.

An optimum M (Magenta, red) toner cartridge is not installed.
Use a toner cartridge that matches your machine.

Y Non Recommended Toner.

An optimum Y (Yellow) toner cartridge is not installed.
Use a toner cartridge that matches your machine.

K Non Recommended Toner.

An optimum K (Black) toner cartridge is not installed.
Use a toner cartridge that matches your machine.

Error Postscript

A postscript error has occurred. Please check data.

Image Drum Near Life.

The image drum indicated on the screen is near life. Have a new image drum ready.
C: Cyan (blue), M: Magenta (red), Y: Yellow, K: Black

Fuser Near Life.

The fuser unit is near life. Have a new fuser unit ready.

Belt Unit Near Life.

The belt unit is near life. Have a new belt unit ready.

Fuser Unit Life. Install New Fuser Unit.

The fuser unit reaches its lifetime.
Replace the fuser unit with a new one.

Belt Unit Life. Install New Belt Unit.

The belt unit reaches its lifetime.
Replace the belt unit with a new one.

Toner empty. Replace with new Toner Cartridge.

The toner indicated on the screen is empty. Replace the empty toner cartridge with a new one.
C: Cyan (blue), M: Magenta (red), Y: Yellow, K: Black

Toner Cartridge Not Installed.

A color toner cartridge indicated on the screen is not installed.
Install the toner cartridge.
C: Cyan (blue), M: Magenta (red), Y: Yellow, K: Black

Image Drum Life. Please install new Image Drum Unit.

The image drum indicated on the screen reaches its lifetime.
Replace the image drum with a new one.
C: Cyan (blue), M: Magenta (red), Y: Yellow, K: Black

[TRAY] empty.

No paper is loaded in the indicated tray. Load paper.

File System is full.

Memory in the file system is full.
Delete unnecessary files.

The File System is write-protected.

The file you are trying to write is write-protected.
Check the file name.

Insufficient page memory to collate.

Insufficient memory error has occurred during collate printing.
Reduce the number of pages to print.

Unauthorized user, job cancelled.

Unauthorized user attempted to print. Data was deleted. Contact your administrator to use this machine.

File erasing ...

Stored document files are being deleted.
Wait for a while.

Erased Data Full

Files supposed to be deleted are full. Erase the files.

Expired saved files have been deleted.

Private printing files whose storage period expired were automatically deleted.

Disk Read/Write Error

An error has occurred in the file system. Press [Close].

Flash Error

An error has occurred when firmware was being updated.
Contact the administrator.

Invalid print data received.

Invalid print data was received. To erase the message, press [Close].
If you performed private printing, the data was deleted because it was incomplete. Print again.

Received data has been discarded because Job Type is restricted.

Data whose job type is not defined in the acceptable job type settings was received. The data was discarded without being processed.
Select a job type defined in the acceptable job type settings for [Job Type] of the printer driver and print again.

 [About Screens and Functions of Each Printer Driver](#)

Feed print job manually. [MEDIA_SIZE]

Print on paper fed manually. Load paper in the MP tray.

Please change [TRAY] paper, Set [MEDIA_SIZE] [MEDIA_TYPE]. Error:461, 462, 463

The size and type of fed paper do not match those indicated on the screen. Use the same size and type of paper selected on the application.

Please change MP Tray paper. Set [MEDIA_SIZE] [MEDIA_TYPE] Error:460

The size and type of paper loaded in the MP tray do not match those indicated on the screen. Make sure that the size and type of paper loaded in the MP tray match those selected on the application.

Wait a moment. Network Configuration writing ...

Network settings for this machine is changed. The new settings are being stored. Wait for a while.

Wait a moment. Network initializing ...

Network settings for this machine are initializing.

Paper [TRAY] is empty Set [MEDIA_SIZE] Error: 490, 491, 492, 493

No paper is loaded in the indicated tray. Load paper of the displayed size.

[TRAY] cassette is missing. Open and Close the indicated cassette. Error: 440, 441, 430, 431, 432

The tray is not installed. Install the cassette. If the cassette is already inserted, pull it out, and then insert it again.

Insufficient memory. Error: 420

Data is too complicated. Memory full error has occurred during processing. Reduce the volume of the print data.

Waste Toner Full Replace with new Toner Cartridge. Error: 415, 416, 417

Waste toner of the toner cartridge is full. Opening and closing the output tray can resume printing for a while, but it may damage the image drum. Replace the toner cartridge with a new one as soon as possible.
C: Cyan (blue), M: Magenta (red)

Toner empty. Replace with new Toner Cartridge. Error: 410, 411, 412, 413

The indicated cartridge ran out of toner.
Opening and closing the output tray can resume printing for a while, but it may damage the image drum. Replace the toner cartridge with a new one as soon as possible.
C: Cyan (blue), M: Magenta (red), Y: Yellow, K: Black

C Non Recommended Toner. Error: 552, 556, 616, 622

The installed C (Cyan, blue) toner cartridge is not optimum.
We recommend using an optimum toner cartridge.

M Non Recommended Toner. Error: 551, 555, 615, 621

The installed M (Magenta, red) toner cartridge is not optimum.
We recommend using an optimum toner cartridge.

Y Non Recommended Toner. Error: 550, 554, 614, 620

The installed Y (Yellow) toner cartridge is not optimum.
We recommend using an optimum toner cartridge.

K Non Recommended Toner. Error: 553, 557, 617, 623

The installed K (Black) toner cartridge is not optimum.
We recommend using an optimum toner cartridge.

Toner cartridge Not Installed. Error: 610, 611, 612, 613

A color toner cartridge indicated on the screen is not installed.
Install the toner cartridge.
C: Cyan (blue), M: Magenta (red), Y: Yellow, K: Black

Image Drum Sensor Error Check Image Drum. Error: 540, 541, 542, 543

A toner sensor error has occurred in the image drum indicated on the screen.
Uninstall the image drum, and then install it again.
If the message persists, uninstall the toner cartridge and install it again.
If the toner cartridge is not installed, install it.
C: Cyan (blue), M: Magenta (red), Y: Yellow, K: Black

Paper Size Error. Reset Paper in [TRAY]. Error: 400

Paper size error has occurred in the indicated tray. Make sure that the size of paper loaded in the tray matches the [Paper Size] setting set on the operator panel. Load paper according to the paper size and direction set. If the setting set on the operator panel is wrong, cancel printing first, set the right paper size from [Paper Size] on the operator panel, and then print again.
Make sure that the cassette does not feed multiple sheets of paper at a time after starting printing. If it happens, remove paper, and then load paper correctly.

Paper jam has occurred. Please open Output Tray to remove paper. Error: 390

Paper jammed via the paper feed path from the MP tray. Remove jammed paper.
If the edge of the jammed paper is not visible, open the output tray and remove the paper.

Paper jam has occurred. Pull out the [TRAY] cassette and then remove the paper. Error: 391, 392, 393

A paper jammed via the paper feed path from the indicated tray.
Pull out the cassette, and then remove paper. If multiple sheets of paper are fed at a time, remove paper and reload paper.
Make sure that the paper stoppers are set in the right position.

A paper jam has occurred under the image drum or around the fuser unit. Please remove paper. Error: 380, 381, 382, 383, 385, 389

A paper jam has occurred inside the machine.
Open the output tray and remove jammed paper.

Paper jam has occurred under the belt unit or around the fuser unit. Please remove paper. Error: 370, 371, 372

A paper jam has occurred inside the machine.
Open the output tray and remove jammed paper.

Image Drum Life. Please install new Image Drum Unit. Error: 350, 351, 352, 353

The image drum indicated on the screen reaches its lifetime.
Replace the image drum with a new one.
Opening and closing the output tray can resume printing for a while. Replace with a new one as soon as possible, however.
C: Cyan (blue), M: Magenta (red), Y: Yellow, K: Black

Image Drum Life. Please install new Image Drum Unit. Error: 560, 561, 562, 563, 564, 565, 566, 567

The image drum indicated on the screen reaches its lifetime.
Replace the image drum with a new one.
C: Cyan (blue), M: Magenta (red), Y: Yellow, K: Black

Image Drum Life. Please install new Image Drum Unit. Error: 680, 681, 682, 683

Printing has stopped because the image drum indicated on the screen reached its lifetime. Replace with a new image drum to print.
C: Cyan (blue), M: Magenta (red), Y: Yellow, K: Black

Fuser Unit Life. Install New Fuser Unit. Error: 354

The fuser unit reaches its lifetime.
Replace the fuser unit with a new one.
Opening and closing the output tray can resume printing for a while. Replace with a new one as soon as possible for maintaining the print quality.

Belt Unit Life. Install New Belt Unit. Error: 355

The belt unit reaches its lifetime.
Replace the belt unit with a new one.
Opening and closing the output tray can resume printing for a while. Replace with a new one as soon as possible for maintaining the print quality.

The Fuser Unit is not installed correctly. Reset Fuser Unit. Error: 348

The fuser unit is not properly installed. Remove and re-install the fuser unit. If the error persists after re-installing, replace the fuser unit with a new one.

Waste Toner Full. Install New Belt Unit. Error: 356

Waste toner of the belt unit is full. Replace the belt unit with a new one. Opening and closing the output tray can resume printing for a while. Replace with a new one as soon as possible for maintaining the print quality.

Toner cartridge not properly installed. Error: 544, 545, 546, 547

A color toner cartridge indicated on the screen is not installed.
Make sure that the lever on the toner cartridge is fully turned and the protective tape is removed.
C: Cyan (blue), M: Magenta (red), Y: Yellow, K: Black

Image Drum not properly installed. Check Image Drum. Error: 340, 341, 342, 343

The indicated image drum is not installed correctly.
Remove and re-install the image drum.
C: Cyan (blue), M: Magenta (red), Y: Yellow, K: Black

The Fuser Unit is not installed correctly. Reset Fuser Unit. Error: 320

The fuser unit is not properly installed. Remove and re-install the fuser unit.

Belt Unit not installed correctly. Re-set the Belt Unit. Error: 330

The belt unit is not properly installed. Remove and re-install the belt unit.

[COVER] Open. Error: 310

Indicated cover is open. Close the cover.
Error: 310 the output tray.

Power OFF/ON

Turn the machine off, and then back on.
If the same error occurs, contact your dealer.

Inspection is required.

Turn the machine off, and then back on.
If the same error occurs, contact your dealer.

Please check SMTP settings.

Cannot connect to the SMTP server. Check the network settings.

Please check POP3 settings.

Cannot connect to the POP3 server. Check the network settings.

SMTP Login failed.

An attempt to log into the SMTP server ended up an authentication error.
Check the network settings.

SMTP Auth. Unsupported

The SMTP server does not support the authentication system.
Check the network settings.

POP3 Login failed.

An attempt to log into the POP3 server ended up an authentication error.
Check the network settings.

Getting target IP failed. Please Check DHCP settings.

The DHCP server cannot be detected. Check the network connection.

Please check DNS settings.

Cannot connect to the DNS server. Check the network connection.

Please insert USB Memory.

Print from USB Memory was attempted with USB Memory not inserted.
Insert USB Memory.

[TRAY] cassette missing.

The cassette in the indicated tray is pulled out.
Install the cassette.

Access Limitation Error Monochrome printing was performed due to the color printing limitation.

A color print job was converted to a mono print job due to an unauthorized user. Contact your administrator for color printing.

Access Limitation Error Data was deleted due to the color printing limitation.

A color print job was deleted due to an unauthorized user. Contact your administrator for color printing.

Restricted access error Data deleted due to printing restrictions.

A print job was deleted due to an unauthorized user. Contact your administrator for printing.

Incompatible USB device connected. Remove the connected USB device.

An unsupported USB device is connected. Remove the USB device.

Please remove the connected USB device. USB device has not been recognized.

The connected USB device was not recognized. Remove the USB device.

Please remove the USB Hub. USB Hub is connected.

A USB hub is connected. Remove the USB hub. This machine does not support USB hub.

Job Log Database Error

A data base access error has occurred while writing or reading the job log. Turning the machine off and on may resolve the problem.
To erase the message, press [Close].

Job Log Buffer Full(Delete old logs)

Old job logs were deleted, because job log buffer was full.

A decoding error occurred. Check the image data.

An error has occurred in the image data sent to this machine. Check the image data.

Process has been canceled as there is no space on the device. Please free up enough memory space by reducing usage and try again.

Processing data was cancelled due to memory full.
Reduce the usage on the device to ensure available memory, and then retry.

Process has been canceled by a device error. After maintenance or change of the device, please try again.

Processing data was cancelled because an error occurred on the device.
Repair or replace the device, and then retry.

Deleting data.

This machine ran out of color toner. Color print data is being deleted.
Wait for a while.

Error PDF

The PDF file is damaged.
Check the file.

This PDF file is password protected.

This PDF file is password protected. Enter a password to print.

Valid password required to print document.

This PDF needs authentication. Enter a password to print.

No communication with the SNTP server.

Obtaining current time from the SNTP server failed. Check the server.

USB Memory disconnected.

The USB Memory was removed while printing from USB Memory. Do not remove USB Memory while printing is in progress.

Cannot open the file.

The specified file could not be Opened. Check the file.

Cannot read the file.

Files could not be read. Check the device where the files are stored.

Image Drum Sensor Error.

The toner sensor error has occurred in the image drum indicated on the screen.
Uninstall the image drum, and then install it again.
If the message persists, uninstall the toner cartridge and install it again.

Rear Output Tray is open, so 2-sided printing is disabled. Error code: 581

2-sided printing failed because the rear output tray is open.
Close the rear output tray and tray again.

Printing was stopped. Rear Output Tray was opened during printing. Open the Output Tray. Error code: 409

The rear output tray was moved while duplex printing.
Close the rear output tray and remove the jammed paper remaining inside of the unit.

Toner empty. Replace with new Toner Cartridge.

The indicated cartridge ran out of toner.
Replace the empty toner cartridge with a new one.

Wait Timeout in menu is disabled. Printing is disabled except by USB. Clear page buffer and enable time out in menu.

Wait Timeout is disabled.

Wireless settings are incomplete.

Wrong values are set or items remain unset in the wireless LAN settings. Check the wireless settings.

Not connected to wireless access point.

No wireless LAN access points are found.
Make sure that the access point is turned on.
Disconnect and re-connect to wireless LAN.

Wireless startup failed.

Turn the machine off, check that the wireless LAN module is correctly installed, and then reboot the machine. If the error persists, contact your dealer.

Firmware Update Error Please try again. If network doesn't work, please try firmware update over USB.

Updating the firmware failed. Update again.

Registering with Google Cloud Print. Don't turn off the power until registration is complete.

This machine is being registered to the Google Cloud Print service. Wait for a while.



Deleting from Google Cloud Print.

This machine is being removed from the Google Cloud Print service. Wait for a while.

Caution, unknown Consumable detected Go to User Manual "Trouble Shooting" to restore operation Error: 709

You can use any consumables in your product, but you must accept the risks of using non-genuine consumables. If the use of non-genuine consumables causes damage to the product or results in your product not functioning to its full specification, then such damage or effect on the product is not covered by warranty.

To accept these risks and to restore function;

- (1) Turn off your product.**
- (2) Press and hold the  (CLEAR) button and turn your product on.**
- (3) After start up, release the  (CLEAR) button.**

Note: This operation will be recorded for future reference.

Replace the image drum. [PAGES] Pages Left.

The image drum indicated on the screen reaches its lifetime.
Replace the image drum with a new one.
C: Cyan (blue), M: Magenta (red), Y: Yellow, K: Black

Receiving data timeout.

Data could not be received within a certain period of time.
Set a longer data reception timeout value.

IPv4 address is conflicted. Please change IPv4 address.

The IP address assigned to this machine is duplicated with that of another device.
Check the IP addresses, and then assign another IP address.

Simplex printing was performed as the paper setting did not allow duplex printing.

Duplex printing is not available on the specified paper.
Check the size and thickness of paper.
Press [Close].

Changing Language. Panel operation is disabled.

Display language is being changed.
Wait for a while.

Language Change Failed. Error num: %CODE%

Switching display languages failed. Press the  (Power) button to turn the machine off, and then back on.

Detected an abnormality of internal database. The data must be deleted. After pressing [Format], the data will be deleted, and then reboot.

Data base is beyond restoration.
To delete the data base, press [Format].

Cannot print because your Summary Account balance is 0. User name for Printing: [USERNAME] Summary Account Name for Insufficient Balance: [ACCOUNTNAME]
To continue the print job, increase the balance and select [Start]. To increase the balance, please contact the device administr. To cancel the print job, select [Cancel].

The number of print jobs exceeds the limit. No more print jobs are authorized. Contact your administrator.

7

Operating Management/Specifications

Changing the Administrator Password

Saving Power Consumption with the Power Save Function

Specifications

This section describes how to manage the machine and its specifications.

Changing the Administrator Password

It is recommended to change the administrator password to protect your security. Set the administrator password using from 6 to 12 alphanumeric characters. Be careful not to forget the set password.

- 1 Press [Device Settings] on the touch panel.
- 2 Press ▲ or ▼ several times and press [Admin Setup].
- 3 Enter the administrator name and password and press [OK].
The factory default administrator name and password are "admin" and "999999" respectively.
- 4 Press ▲ or ▼ several times and press [Manage Unit].
- 5 Press ▲ or ▼ several times and press [Admin Password].
- 6 Enter a new password, and then press [OK].
- 7 Enter the password again.
- 8 Press [OK].

Saving Power Consumption with the Power Save Function

The machine has three Power Save modes: Power Save, Sleep, and Deep Sleep.

In Power Save mode, the display screen turns off and the power saving indicator lights up or blinks.

Press the  (POWER SAVE) button to enter Power Save mode.

After being left unoperated for a certain period of time (a minute by factory default), the machine automatically enters Power Save mode.

After being left unoperated for a certain period of time (15 minutes by factory default) in Power Save mode, the machine enters Sleep mode, Deep Sleep mode.







- For details on how to change the idle time before entering Power Save mode, see "Setting the Length of Idle Time Before Entering Power Save Mode".
- For details on how to change the idle time before entering Sleep mode, see "Setting the Length of Idle Time Before Entering Sleep Mode".

Press the  (POWER SAVE) button to recover from Power Save mode. The machine also recovers from Power Save mode, when some data is received from a computer or another device.

- Setting the Length of Idle Time Before Entering Power Save Mode
- Setting the Length of Idle Time Before Entering Sleep Mode
- Restrictions in Power Saving Function
- Automatically Turning the Machine Off (Auto Power Off)
- Setting the Length of Idle Time Before Auto Power Off Works

Setting the Length of Idle Time Before Entering Power Save Mode

- 1 Press [Device Settings] on the touch panel.
- 2 Press  or  several times and press [Admin Setup].
- 3 Enter the administrator name and password and press [OK].
The factory default administrator name and password are "admin" and "999999" respectively.
- 4 Press  or  several times and press [Manage Unit].
- 5 Press [Power Save].
- 6 Press [Power Save Time].
- 7 Select transition time.

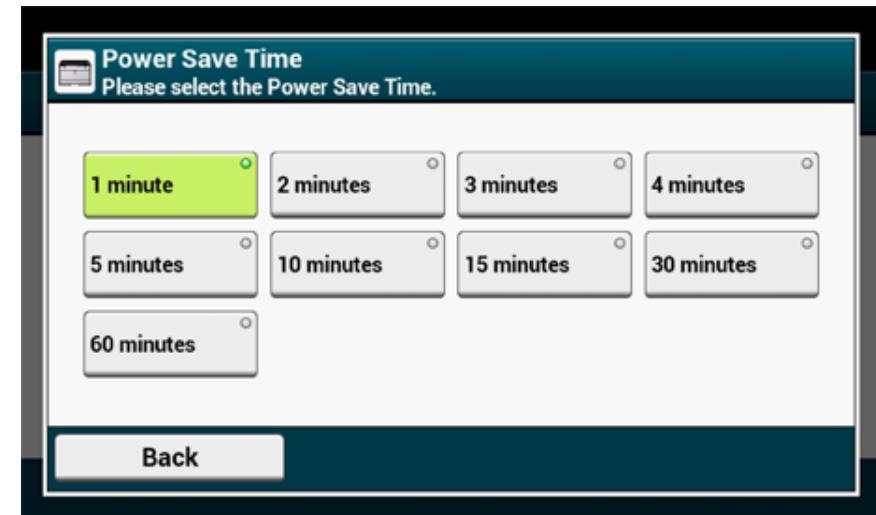

Setting the Length of Idle Time Before Entering Sleep Mode

- 1 Press [Device Settings] on the touch panel.
- 2 Press ▲ or ▼ several times and press [Admin Setup].
- 3 Enter the administrator name and password and press [OK].
The factory default administrator name and password are "admin" and "999999" respectively.
- 4 Press ▲ or ▼ several times and press [Manage Unit].
- 5 Press [Power Save].
- 6 Press [Sleep Time].
- 7 Select transition time.

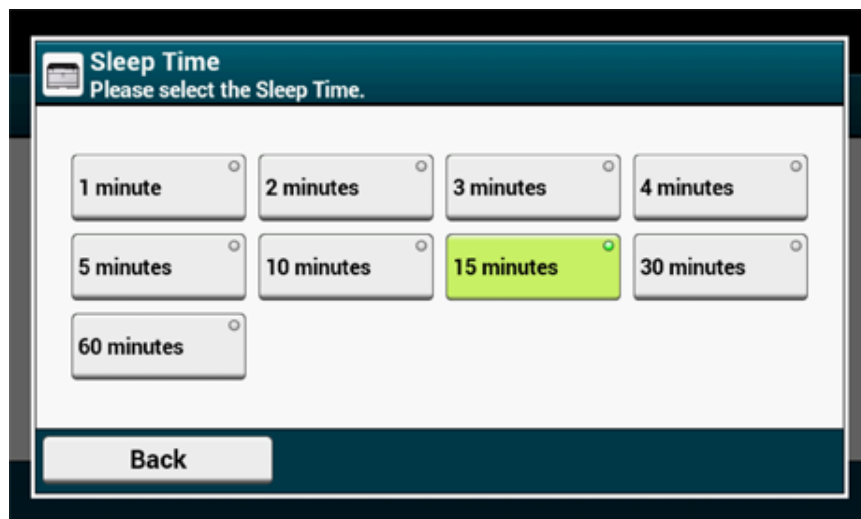

Restrictions in Power Saving Function

The machine does not enter Sleep mode in the following case.

- When an error occurs on the machine
- Access Control in the Access Control settings is enabled and Local IC Card or LDAP IC Card in the Authentication Method is enabled.

The machine does not enter Deep Sleep mode in the following cases.

- IPsec is enabled
- A TCP connection is established
Example: A connection is established with Telnet or FTP.
When the transition time to enter Sleep mode or Deep Sleep mode from Power Save mode elapses and the connection is disconnected, the machine enters Sleep mode.
- E-mail reception is enabled
- Wireless LAN is enabled
- Google Cloud Print is enabled
- LLTD is enabled
- IPv6 Global Address is assigned

In Deep Sleep mode, you cannot use the following protocols to print.

- NBT

In Deep Sleep mode, you cannot search or set by using the following functions and protocols.

- NBT

In Deep Sleep mode, the following protocols that have the client function do not operate.

- E-mail alert*2
- SNMP Trap
- WINS*1
- SNTP*2

*1 The elapse time in Deep Sleep mode is not included in the intervals of WINS update time.

WINS regular updates are not performed in Deep Sleep mode, possibly resulting in names that are registered in the WINS server being deleted.

*2 The elapse time in Deep Sleep mode is not included in the intervals of the e-mail alert notification time and the intervals of the NTP server update time.

In a network environment where a large number of packets are sent, the machine automatically exits Deep Sleep mode to Sleep mode and responds.

Also, if a terminal that runs searches with Bonjour, such as Mac or iPhone, is connected to the same network, the machine automatically exits Deep Sleep mode to Sleep mode and responds.

This machine automatically enters Deep Sleep mode after a certain period of time.

Automatically Turning the Machine Off (Auto Power Off)

The machine equipped with the Auto Power Off function which automatically turns the power off if the machine is left unoperated for a certain period of time.

There are three options for the Auto Power Off setting and [Auto Config] is set by factory default.

- [Auto Config]: The machine automatically turns off after being left unoperated for a certain period of time unless the machine is in the following conditions.
 - A LAN cable is connected to the network interface connector.
 - Wireless LAN is enabled.
- [Enable]: If you do not use the machine for a certain period of time, the machine automatically turns off.
- [Disable]: Disables the Auto Power Off function. The machine does not automatically turn off.



The machine does not automatically turn off in the following case.

- When an error has occurred

Follow the steps below to change the Auto Power Off setting.

- 1 Press [Device Settings] on the touch panel.
- 2 Press ▲ or ▼ several times and press [Admin Setup].
- 3 Enter the administrator name and password and press [OK].
The factory default administrator name and password are "admin" and "999999" respectively.
- 4 Press ▲ or ▼ several times and press [User Install].
- 5 Press [Power Setup].
- 6 Press [Auto Power Off].
- 7 Select the value.

Setting the Length of Idle Time Before Auto Power Off Works

- 1 Press [Device Settings] on the touch panel.
- 2 Press ▲ or ▼ several times and press [Admin Setup].
- 3 Enter the administrator name and password and press [OK].
The factory default administrator name and password are "admin" and "999999" respectively.
- 4 Press ▲ or ▼ several times and press [Manage Unit].
- 5 Press [Power Save].
- 6 Press [Auto Power Off Time].
- 7 Select transition time.

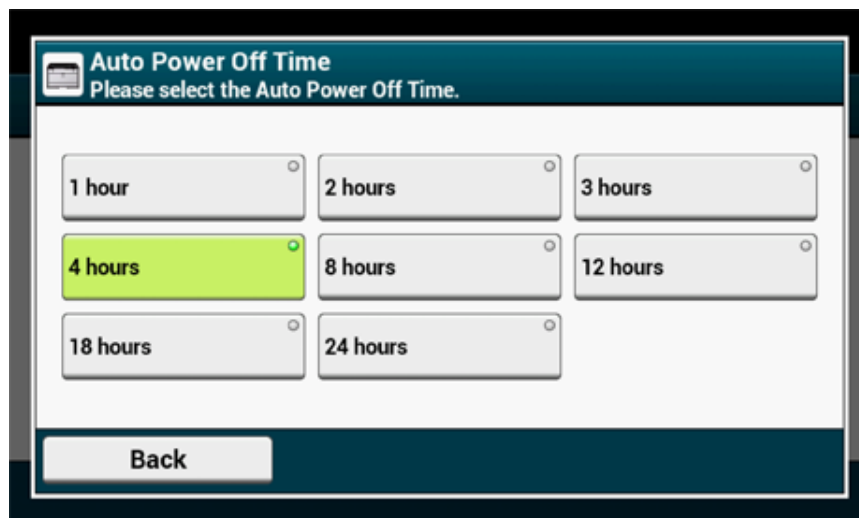

Specifications

This section describes the specifications of the machine.

- General Specifications
- Printing Specifications
- Network Specifications
- Wireless LAN Specifications (Option)

General Specifications

Item		C542/ES5442
CPU		ARM Processor (667MHz)
Memory		DDR3 32bit 1GB
ROM		3GB
Weight (including consumables)		approx. 24 kg
Dimensions (W x D x H)		427 x 571 x 279 mm
Power supply		N36302A: 120V AC +/-10 N36302B: 230V AC +/-10
Power consumption	Typical operation	N36302A: 670 W / N36302B: 640 W
	Idle	90 W
	Peak	N36302A: 1220 W / N36302B: 1250 W
	Power save mode	Less than 14 W
	Sleep mode	Less than 7.8 W
	Deep Sleep mode	Less than 1.1 W
	Auto power off mode	Less than 0.5 W
Operating condition	Operating	Temperature : 10 - 32°C, Humidity : 20 - 80% RH
	Idle	Temperature : 0 - 43°C, Humidity : 10 - 90% RH
Interface		USB 2.0, Ethernet 10BASE-T/100BASE-TX/1000BASE-T, Host USBx2 IEEE802.11 b/g/n/a Wireless LAN (Option)
Display		Color touch panel 7 inches, WVGA (800 x 480)
Supported OS		Windows 10/Windows 8.1/Windows Server 2012 R2/ Windows 8/Windows Server 2012/Windows 7/ Windows Vista/Windows Server 2008 R2/Windows Server 2008 Mac OS X 10.8.5 to 10.11

Printing Specifications

Item	C542/ES5442	
Printing method	Dry electrophotographic recording method with LED (Light-emitting diode)	
Page-description language	PostScript 3, PCL5c, PCL6 (XL), EPSON FX, IBM ProPrinter, XPS, PDF (v1.7 or earlier)	
Resident fonts	PCL: 91 European fonts PS: 80 European fonts	
Resolution	1200 x 1200 dpi, 600 x 600 dpi	
Color	Yellow, Magenta, Cyan, Black	
Print speed	<ul style="list-style-type: none"> A4 Simplex: Up to 30 ppm Duplex: Up to 16 ppm (mono), 14 ppm (color) Letter Simplex: Up to 31 ppm Duplex: Up to 16 ppm (mono), 14 ppm (color) 	
First print out time	Color	Approx. 7.5 seconds (A4)
	Mono	Approx. 7.5 seconds (A4)
Paper size	Tray 1	Legal 13/13.5/14, Letter, Executive, A4, A5, A6, B5, B6, Statement, 8.5 SQ, Folio, 16K (197 x 273 mm, 195 x 270 mm, 184 x 260 mm), Custom size
	Additional tray unit (Optional)	Legal 13/13.5/14, Letter, Executive, A4, A5, B5, 8.5 SQ, Folio, 16K (197 x 273 mm, 195 x 270 mm, 184 x 260 mm), Custom size
	MP Tray	Legal 13/13.5/14, Letter, Executive, A4, A5, A6, B5, B6, B6 Half, Statement, 8.5 SQ, Folio, Index card (3x5inches), 4 x 6 inches, 5 x 7 inches, Banner up to 1321 mm (52 inches), 16K (197 x 273 mm, 195 x 270 mm, 184 x 260 mm), C5, DL, Com-9, Com-10, Monarch, Custom size
	Duplex Printing	Legal 13/13.5/14, Letter, Executive, A4, A5, B5, 8.5 SQ, Folio, 16K (197 x 273 mm, 195 x 270 mm, 184 x 260 mm), Custom size
	Custom size	<ul style="list-style-type: none"> Tray 1 100 - 216 mm (W), 148 - 356 mm (L) (3.9 - 8.5 inches (W), 5.8 - 14.0 inches (L)) Additional tray unit (optional) 148 - 216 mm (W), 210 - 356 mm (L) (5.8 - 8.5 inches (W), 8.2 - 14.0 inches (L)) MP tray 64 - 216 mm (W), 90 - 1321 mm (L) (2.5 - 8.5 inches (W), 3.5 - 52 inches (L)) Duplex 148 - 216 mm (W), 210 - 356 mm (L) (5.8 - 8.5 inches (W), 8.2 - 14.0 inches (L))
Media type	Plain paper (64 g/m ² - 220 g/m ²), Envelopes, Label	
Feeding method	Automatic feeding from Tray 1, MP tray and Additional tray unit (optional) Manual feeding from MP tray	

Item	C542/ES5442
Paper loading capacity	<ul style="list-style-type: none"> Tray 1 250 sheets (less than 80 g/m²), total thickness 25 mm or lower. MP tray 100 sheets (less than 80 g/m²) and total thickness 10 mm or lower, 10 envelopes (85 g/m²). Additional tray unit (optional) 530 sheets of Standard paper /80 g/m² and total thickness 53 mm or lower.
Output method	Face up/Face down
Paper output capacity	<ul style="list-style-type: none"> Output Tray 150 sheets (less than 80 g/m²) Rear Output Tray 100 sheets (less than 80 g/m²)
Print guaranteed area	6.35 mm or more from the paper edge (not applicable to special media such as envelopes)
Print precision	Print beginning: ± 2 mm, paper skew: ± 1 mm/100 mm Image expansion: ± 1 mm/100 mm (80 g/m ²)
Warm-up time	<ul style="list-style-type: none"> From power on 35 seconds (at room temperature 25°C) From sleep mode 38 seconds (at room temperature 25°C)
Usage Environment Conditions	<ul style="list-style-type: none"> When in operation 10 - 32°C/ Relative Humidity of 20 - 80% (maximum wet bulb temperature of 25°C, maximum dry bulb temperature of 2°C) When not in operation 0 - 43°C/ Relative Humidity of 10 - 90% (maximum wet bulb temperature of 26.8°C, maximum dry bulb temperature of 2°C)
Conditions for the guarantee of print quality	<ul style="list-style-type: none"> Operating Range Temperature 10°C, humidity 20 to 80% RH Temperature 32°C, humidity 20 to 60% RH Humidity 20% RH, temperature 10 to 32°C Humidity 80% RH, temperature 10 to 27°C Full-color Print Quality Assured Range Temperature 17 to 27°C, humidity 50 to 70% RH
Consumables	Toner cartridges, Image drums, Belt unit, Fuser unit

Network Specifications

Item	C542/ES5442
Interface	Ethernet 10BASE-T/100BASE-TX/1000BASE-T, IEEE802.11 a/b/g/n Wireless LAN
Protocol	TCP/IPv4, TCP/IPv6, NetBIOS over TCP, LPR, Port9100, IPP, FTP, HTTP, TELNET, SMTP, POP3, SNMPv1/v3, DHCP, DHCPv6, DNS, DDNS, UPnP, WINS, Bonjour, SNTP, LLTD, Web Services Discovery (WSD), SSL/TLS, IPSec, LDAPv3, Kerberos, IEEE802.1X, AirPrint, Google Cloud Print

Wireless LAN Specifications (Option)

Item	C542/ES5442
Wireless LAN standard	IEEE802.11a/b/g/n conformity (2.4 GHz / 5 GHz)
Security	Disable, WEP, WPA-PSK, WPA2-PSK, WPA-EAP, WPA2-EAP

Regulatory wireless LAN statements

- FCC Statement
- IC Statement
- Europe-CE Declaration of conformity.

FCC statement

FCC WARNING

Changes or modifications not expressly approved by the party responsible for compliance could void the user's authority to operate the equipment.

Note: This equipment has been tested and found to comply with the limits for a Class B digital device, pursuant to part 15 of the FCC Rules. These limits are designed to provide reasonable protection against harmful interference in a residential installation. This equipment generates, uses and can radiate radio frequency energy and, if not installed and used in accordance with the instructions, may cause harmful interference to radio communications. However, there is no guarantee that interference will not occur in a particular installation. If this equipment does cause harmful interference to radio or television reception, which can be determined by turning the equipment off and on, the user is encouraged to try to correct the interference by one or more of the following measures:

- Reorient or relocate the receiving antenna.
- Increase the separation between the equipment and receiver.
- Connect the equipment into an outlet on a circuit different from that to which the receiver is connected.
- Consult the dealer or an experienced radio/TV technician for help.

This transmitter must not be co-located or operating in conjunction with any other antenna or transmitter.

IC statement

This device complies with Part 15 of FCC Rules and Industry Canada licence-exempt RSS standard(s). Operation is subject to the following two conditions: (1) this device may not

cause interference, and (2) this device must accept any interference, including interference that may cause undesired operation of this device.

Le présent appareil est conforme aux la partie 15 des règles de la FCC et CNR d'Udustrie Canada applicables aux appareils radio exempts de licence. L'exploitation est autorisée aux deux conditions suivantes : (1) l'appareil ne doit pas produire de brouillage, et (2) l'utilisateur de l'appareil doit accepter tout brouillage radioélectrique subi, même si le brouillage est susceptible d'en compromettre le fonctionnement.

This Class [B] digital apparatus complies with Canadian ICES-003.

Cet appareil numérique de la classe [B] est conforme à la norme NMB-003 du Canada.

Caution (FCC/IC):

5.15-5.25 GHz band is restricted to indoor operations only.

La bande 5150-5250 MHz est restreints à une utilisation à l'intérieur.

This equipment complies with FCC/IC radiation exposure limits set forth for an uncontrolled environment and meets the FCC radio frequency (RF) Exposure Guidelines and RSS-102 of the IC radio frequency (RF) Exposure rules. This equipment should be installed and operated keeping the radiator at least 20 cm or more away from person's body.

Cet équipement est conforme aux limites d'exposition aux rayonnements énoncées pour un environnement non contrôlé et respecte les règles les radioélectriques (RF) de la FCC lignes directrices d'exposition et d'exposition aux fréquences radioélectriques (RF) CNR-102 de l'IC. Cet équipement doit être installé et utilisé en gardant une distance de 20 cm ou plus entre le dispositif rayonnant et le corps.

Europe - CE Declaration of Conformity



This equipment complies with the essential requirements of the European Union directive 1999/5/EC.

The telecommunications functionality of this product may be used in the following EU and EFTA countries: Austria, Belgium, Bulgaria, Cyprus, Czech Republic, Denmark, Estonia, Finland, France, Germany, Greece, Hungary, Iceland, Ireland, Italy, Latvia, Liechtenstein, Lithuania, Luxembourg, Malta, Netherlands, Norway, Poland, Portugal, Romania, Slovak Republic, Slovenia, Spain, Sweden, Switzerland, Turkey and United Kingdom.

Contact Us

OKI Systems (UK) Ltd.

Blays House
Wick Road
Egham
Surrey
TW20 0HJ
Tel: +44 (0) 1784 274300
Website: www.oki.com/uk

OKI Systems (Ireland) Ltd

A7 Calmount Park
Ballymount
Dublin 12
D12 TX94
Ireland
Tel: +353 (0) 1 4049590
Fax: +353 (0) 1 4049591
Website: www.oki.com/ie

OKI Systems (Czech and Slovakia), s.r.o.

Futurama Business Park -
Sokolovská 651/136A
186 00 Praha 8
Czech Republic
Tel: +420 224 890158
Fax: +420 22 232 6621
Website: www.oki.cz, www.oki.sk

Oki Systems (Deutschland) GmbH

Hansaallee 187
40549 Düsseldorf
Tel: +49 (0) 211 / 5266-0
Fax: +49 (0) 211 59 33 45
Website: www.oki.de

Albania, Bosnia, Bulgaria, Croatia,
Cyprus, Estonia, Greece, Israel,
Latvia, Lithuania, Macedonia,
Romania, Serbia, Slovenia

CEE Export Group: OKI Systems (Poland) Sp. z o.o.

Platinum Business Park 2, 3rd Floor
ul. Domaniewska 42, 02-672 Warsaw
Poland
Tel: +48 (0) 22 448 65 00
Fax: +48 (0) 22 448 65 00
Website: www.oki.pl

Oki Systèmes (France) S.A.

Zone Silic - Immeuble Osaka
21 rue du Jura
CS 90277
94633 RUNGIS Cedex
Paris
Tél: Standard 0820 200 410
(0.09€/min depuis une ligne fixe*)
Hotline 01 76 54 21 50 (n° non
surtaxé)
Website: www.oki.fr

OKI Systems (Magyarország) Kft.

H-1133 Budapest,
Váci út 76
Hungary
Telefon: +36 1 814 8000
Telefax: +36 1 814 8009
Website: www.okihu.hu

OKI Systems (Italia) S.p.A.

via Milano, 11,
20084 Lacchiarella (MI)
Tel: +39 (0) 2 900261
Fax: +39 (0) 2 90026344
Website: www.oki.it

OKI Systems (Polska) Sp. z o.o.

Platinum Business Park II, 3rd
Floor
ul. Domaniewska 42
02-672 Warsaw
Poland
Tel: +48 22 448 65 00
Fax: +48 22 448 65 01
Website: www.oki.pl
E-mail: oki@oki.com.pl
Hotline: 0800 120066
E-mail: tech@oki.com.pl

OKI Europe Limited, Sucursal em Portugal

Av. Quinta Grande 53
7º D Alfragide
2614-521 Amadora
Portugal
Tel: +351 21 470 4200
Fax: +351 21 470 4201
Website: www.oki.pt
E-mail: oki@oki.pt

Oki Service Serviço de apoio técnico ao Cliente

Tel: 214 727 660
E-mail: okiserv@oki.pt

OKI Systems Rus, LLC (Russia)

Sector B, 3rd Floor, Svyatogor-4
Business Center10/4, Letnikovskaya
str.115114, Moscow
Tel: +7 495 276 5060
Fax: +7 495 258 6070
e-mail: info@oki.ru
Website: www.oki.ru
Technical support:
Tel: +7 495 564 8421
e-mail: tech@oki.ru

Oki Systems (Österreich) Kft.

Campus 21
Businesszentrum Wien Sued
Liebermannstrasse A02 603
22345 Brun am Gebirge
Tel: +43 223 6677 110
Service-Hotline:
+43 (0) 2236/677 110-501
Website: www.oki.at

OKI Europe Ltd. (Ukraine)

Raisy Opkinoy Street,8
Building B, 2nd Floor,
Kiev 02002
Ukraine
Tel: +380 44 537 5288
e-mail: event@oki.ua
Website: www.oki.ua

OKI Sistem ve Yazici Çözümleri Tic. Ltd. Şti.

Harman sok Duran Is Merkezi,
No:4, Kat:6,
34394, Levent
İstanbul
Tel: +90 212 279 2393
Faks: +90 212 279 2366
Web: www.oki.com.tr

Oki Systems (Belgium)

Medialaan 24
1800 Vilvoorde
Helpdesk: 02-2574620
Fax: 02 2531848
Website: www.oki.be

OKI Systems (Denmark) a-s

Herstedøstervej 27
2620 Albertslund
Danmark
Adm.: +45 43 66 65 00
Fax: +45 43 66 65 90
E-mail: salg@oki.dk /
support@oki.dk
Website: www.oki.dk

OKI Europe Limited, Sucursal en España

Complejo Vega Norte. C/ Anabel
Segura, 16. Edif. 3 - 4º Pta.
28.108, Alcobendas
Madrid
Tel +34 91 343 16 20
Website: www.oki.es

OKI Middle East, India and Sub Sahara Africa

Building 7W A
Office 2008,
Dubai Airport Free Zone
PO Box 54604
Dubai, UAE
Tel: +971 4 204 5810
Website: www.oki.com/me

Oki Systems (Finland) Oy

Vänrikinkuja 3
02600 Espoo
Tel: +358 (0) 207 900 800
Fax: +358 (0) 207 900 809
Website: www.oki.fi

Oki Systems (Holland) b.v.

Neptunstraat 27-29
2132 JA Hoofddorp
Helpdesk: 0800 5667654
Tel: +31 (0) 23 55 63 740
Fax: +31 (0) 23 55 63 750
Website: www.oki.nl

Oki Systems (Norway) AS

Tevlingveien 23
N-1081 Oslo
Tel: +47 (0) 63 89 36 00
Telefax: +47 (0) 63 89 36 01
Website: www.oki.no

Var vänlig kontakta din
Återförsäljare i första hand, för
konsultation. I andra hand kontakta

Oki Systems (Sweden) AB

Box 1193
164 26 Kista
Tel. +46 (0) 8 634 37 00
e-mail: info@oki.se
Website: www.oki.se

Oki Systems (Schweiz)

Baslerstrasse 15
CH-4310 Rheinfelden
Support deutsch +41 61 827 94 81
Support français +41 61 827 94 82
Support italiano +41 061 827 9473
Tel: +41 61 827 9494
Website: www.oki.ch

Oki Data Americas Inc.(United States • États-Unis)

2000 Bishops Gate Blvd.
Mt. Laurel, NJ 08054
USA
Tel: 1-800-654-3282
Fax: 1-856-222-5247
http://www.OKIPRINTINGSOLUTIONS.COM
http://my.okidata.com

8505 Freeport Pkwy
Suite 100
Irving, TX 75063
http://www.okidata.com

2067 Wineridge Place
Suite C & D
Escondido, CA 92029
Phone: 760-781-5200
Toll Free: 800-264-1272
http://www.okidata.com/wide-format

Oki Data Americas Inc.(Canada • Canadá)

4140B Sladeview Crescent Unit 7 & 8
Mississauga, Ontario
Canada L5L 6A1

Tél: 1-905-608-5000
Téléfax: 1-905-608-5040
http://www.OKIPRINTINGSOLUTIONS.COM

Oki Data Americas Inc.(América Latina (OTRO))

2000 Bishops Gate Blvd.
Mt. Laurel, NJ 08054
USA

Tel (Español): 1-856-222-7496
1-856-222-5276
Fax: 1-856-222-5260
Email: LASatisfaction@okidata.com

Oki Data de Mexico, S.A. de C.V.

Mariano Escobedo #748, Piso 8
Col. Nueva Anzures
C.P. 11590, México, D.F.

Tel: 52-555-263-8780
Fax: 52-555-250-3501
http://www.OKIPRINTINGSOLUTIONS.COM

Oki Data do Brasil Informática Ltda.

Av. Alfredo Egídio de Souza Aranha,
100 - 5º Andar - Bloco C
Chácara Santo Antonio - São Paulo,
SP - Brasil
CEP: 04726-170

Tel: 55-11-3543-5500
Fax: 55-11-3444-3501
email: okidata@okidata.com.br
HTTP://www.okiprintingsolutions.com

Argentina/Chile/Paraguay/Perú/ Uruguay

Oki Data Americas, Inc.
Sucursal Argentina
Ugarte 3610 Piso 4º(1605) Olivos
Buenos Aires, Argentina
TEL: +54 11 5288 7500
Fax: +54 11 5288 7599

Colombia/Ecuador/Venezuela/ Centroamérica y Caribe Oki Data Americas, Inc.

Sucursal Colombia
Carrera 13 #97-51, Oficina 101
Bogotá Colombia
TEL: +57 1 704 5159

Oki Data (Singapore) Pte. Ltd.

438A Alexandra Road #02-11/12,
Lobby 3, Alexandra Technopark
Singapore(119967)
Tel: (65) 6221 3722
Fax: (65) 6594 0609
http://www.okidata.com.sg

Oki Systems (Thailand) Ltd.

1168/32 Lumpini Tower,
16th Floor, Rama IV Road,
Tungmahamek, Sathorn
Bangkok 10120
Tel: (662) 679 9235
Fax: (662) 679 9243/245
http://www.okisysthai.com

Oki Data(Australia) Pty Ltd.

Level1 67 Epping Road, Macquarie
Park
NSW 2113, Australia
Tel: +61 2 8071 0000
(Support Tel: 1800 807 472)
Fax: +61 2 8071 0010
http://www.oki.com.au

OKI Data New Zealand

8 Antares Place Rosedale,
Auckland, 0632 New Zealand
Tel: (64) 9 477 0500
(Customer Support: 0800 778 800)
Fax: (64) 9 477 0549
http://www.oki.co.nz/

Oki Data(S) P Ltd. Malaysia Rep Office

Suite 21.03, 21st Floor Menara IGB,
Mid Valley City,
Lingkaran Syed Pura 59200,
Kuala Lumpur, Malaysia
Tel: (60) 3 2287 1177
Fax: (60) 3 2287 1166

